



Solid-State Light. Done Right.

APPROVAL SHEET

AOT MODEL NAME	3004
AOT PART NUMBER	3004C-W30Q
CUSTOMER NAME	General
DATE	2021 / Oct
Version	01

MAKER			CUSTOMER			
Prepared	Checked	Approved				
<i>Rick Wu</i>	<i>Sam Kuo</i>	<i>Sinfan Lo</i>				

AOT Headquarters
No. 13, Gongye 5th. Road, Hsinchu Industrial Park, Hukou Shiang,
Hsinchu Hsien 303, Taiwan, R.O.C.
TEL: +886-3-597-6988 / FAX: +886-3-598-7392

Package Outline

Model name:3004C-W30Q

Unit: mm, Tolerance: ± 0.1 mm

Front view

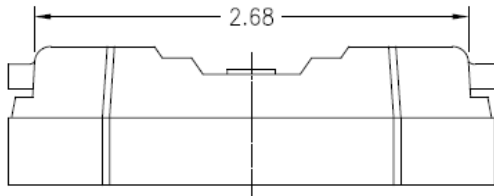

Cathode (2)  Anode (1)

Top view

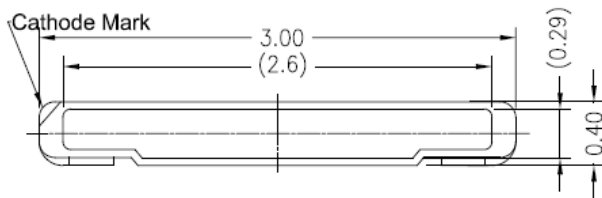

Back view

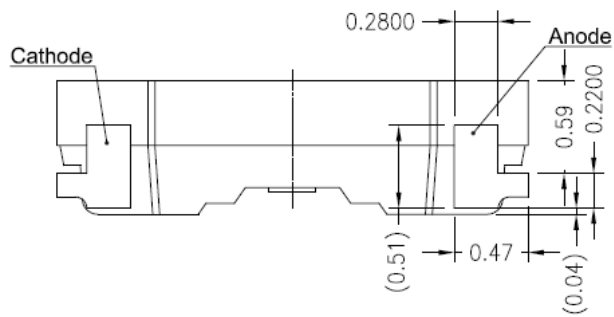

Side view

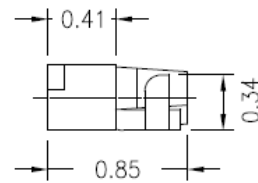

Recommended Soldering Pad design (Unit :mm)

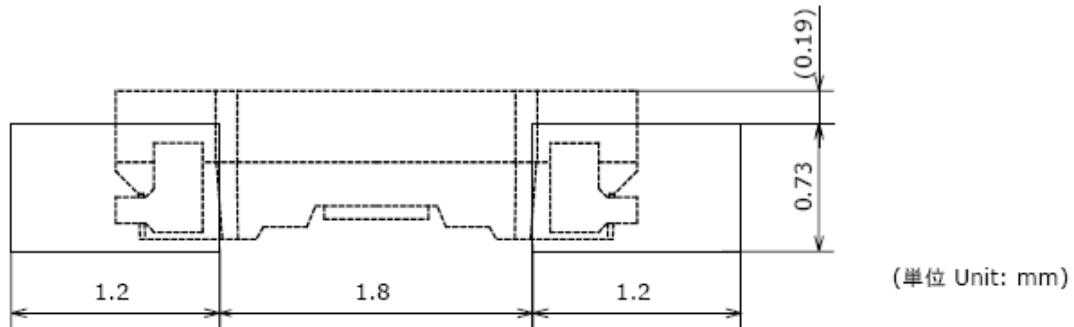

Item	Materials
Package	High Temperature Resistant Plastic, PPA.
Encapsulating	Silicone Resin(with phosphor)
Electrode	Cu Alloy With Ni, Ag Plating.

- SMD type Side-View white LED.
- Lead frame package with individual 2 pins.
- Wide viewing angle(120°)
- Compatible with reflow soldering.
- Complies with RoHS Directive.
- The Encapsult surface should be under the package surface, and should not expose the wire.
- Compact package outline (L x W x H) of 3.0 mm x 0.85mm x 0.4 mm.

Optical/ Electronic Characteristics (T_A= 25°C)

Item	Symbol	Condition	Min	Typ	Max	Unit
Forward Voltage	V _F	I _F =20mA	2.7	-	3	V
Luminous Flux	Φ _V	I _F =20mA	6.5	-	7.5	lm
Reverse Current	I _R	V _R = -7V	-	-	0.05	μA

* Tolerance of measurements of the Forward Voltage is ± 0.05 V.

* Tolerance of measurements of the Luminous Flux is ± 5%.

Absolute Maximum Ratings (T_A=25°C)

Item	Symbol	Absolute Maximum Rating	Unit
Forward Current	I _F	30	mA
*Pulse Forward Current	I _{FP}	80	mA
*Reverse Voltage	V _R	5	V
Power Dissipation	P _D	90	mW
Operating Temperature	T _{opr}	-40~+85	°C
Storage Temperature	T _{stg}	-40~+100	°C
Soldering Temperature	T _{sld}	Reflow Soldering : 260°C for 10sec Hand Soldering : 350°C for 3sec	
Junction Temperature	T _j	105	°C
Forward Voltage at Low Current	VF2	>1.9 (@1 μA)	V

* I_{FP} Conditions : Pulse Width ≤ 10msec, and duty ≤ 1/10

* Max condition is not guarantee for life time



Solid-State Light. Done Right.

Group Definition of Forward Voltage

Rank	Condition	VF(V)	
		Min.	Max.
V7	T _A = 25°C I _F = 20mA	2.7	2.8
V8		2.8	2.9
V9		2.9	3.0

Group Definition of Brightness

Rank	Condition	Luminous Intensity	
		φ v (lm)	
		Min.	Max.
NW650	T _A =25°C I _F =20mA	6.50	6.75
NW675		6.75	7.00
NW700		7.00	7.25
NW725		7.25	7.50

*A shipment shall consist of LEDs in a combination of above ranks.

*The percentage of each rank in the shipment shall be determined by AOT.

*The ranking information of LEDs can be found on the reel label.

Group Definition of Chromaticity Coordinate

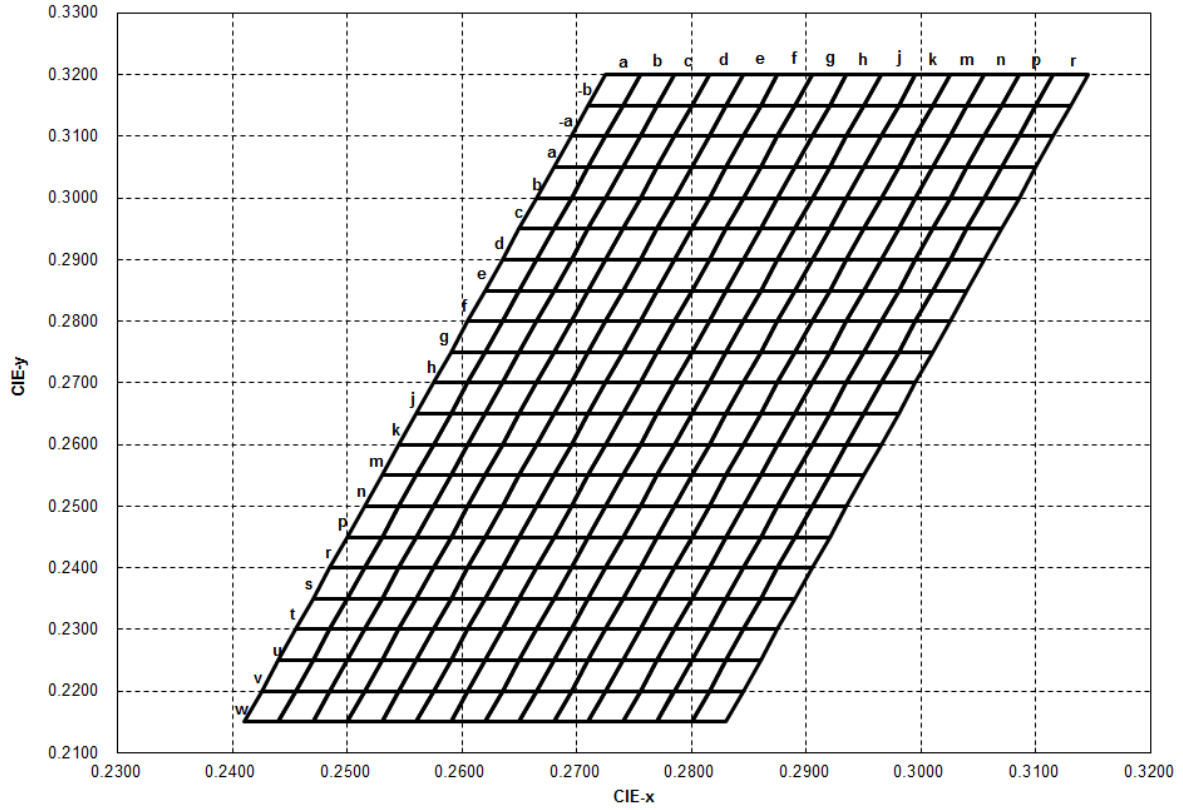

Rank	x	y	Rank	x	y	Rank	x	y
wa	0.2410	0.2150	wb	0.2440	0.2150	wc	0.2470	0.2150
	0.2425	0.2200		0.2455	0.2200		0.2485	0.2200
	0.2455	0.2200		0.2485	0.2200		0.2515	0.2200
	0.2440	0.2150		0.2470	0.2150		0.2500	0.2150
va	0.2425	0.2200	vb	0.2455	0.2200	vc	0.2485	0.2200
	0.2440	0.2250		0.2470	0.2250		0.2500	0.2250
	0.2470	0.2250		0.2500	0.2250		0.2530	0.2250
	0.2455	0.2200		0.2485	0.2200		0.2515	0.2200
ua	0.2440	0.2250	ub	0.2470	0.2250	uc	0.2500	0.2250
	0.2455	0.2300		0.2485	0.2300		0.2515	0.2300
	0.2485	0.2300		0.2515	0.2300		0.2545	0.2300
	0.2470	0.2250		0.2500	0.2250		0.2530	0.2250
ta	0.2455	0.2300	tb	0.2485	0.2300	tc	0.2515	0.2300
	0.2470	0.2350		0.2500	0.2350		0.2530	0.2350
	0.2500	0.2350		0.2530	0.2350		0.2560	0.2350
	0.2485	0.2300		0.2515	0.2300		0.2545	0.2300
sa	0.2470	0.2350	sb	0.2500	0.2350	sc	0.2530	0.2350
	0.2485	0.2400		0.2515	0.2400		0.2545	0.2400
	0.2515	0.2400		0.2545	0.2400		0.2575	0.2400
	0.2500	0.2350		0.2530	0.2350		0.2560	0.2350
ra	0.2485	0.2400	rb	0.2515	0.2400	rc	0.2545	0.2400
	0.2500	0.2450		0.2530	0.2450		0.2560	0.2450
	0.2530	0.2450		0.2560	0.2450		0.2590	0.2450
	0.2515	0.2400		0.2545	0.2400		0.2575	0.2400



Solid-State Light. Done Right.

Rank	x	y	Rank	x	y	Rank	x	y
pa	0.2500	0.2450	pb	0.2530	0.2450	pc	0.2560	0.2450
	0.2515	0.2500		0.2545	0.2500		0.2575	0.2500
	0.2545	0.2500		0.2575	0.2500		0.2605	0.2500
	0.2530	0.2450		0.2560	0.2450		0.2590	0.2450
na	0.2515	0.2500	nb	0.2545	0.2500	nc	0.2575	0.2500
	0.2530	0.2550		0.2560	0.2550		0.2590	0.2550
	0.2560	0.2550		0.2590	0.2550		0.2620	0.2550
	0.2545	0.2500		0.2575	0.2500		0.2605	0.2500
ma	0.2530	0.2550	mb	0.2560	0.2550	mc	0.2590	0.2550
	0.2545	0.2600		0.2575	0.2600		0.2605	0.2600
	0.2575	0.2600		0.2605	0.2600		0.2635	0.2600
	0.2560	0.2550		0.2590	0.2550		0.2620	0.2550
ka	0.2545	0.2600	kb	0.2575	0.2600	kc	0.2605	0.2600
	0.2560	0.2650		0.2590	0.2650		0.2620	0.2650
	0.2590	0.2650		0.2620	0.2650		0.2650	0.2650
	0.2575	0.2600		0.2605	0.2600		0.2635	0.2600
ja	0.2560	0.2650	jb	0.2590	0.2650	jc	0.2620	0.2650
	0.2575	0.2700		0.2605	0.2700		0.2635	0.2700
	0.2605	0.2700		0.2635	0.2700		0.2665	0.2700
	0.2590	0.2650		0.2620	0.2650		0.2650	0.2650
ha	0.2575	0.2700	hb	0.2605	0.2700	hc	0.2635	0.2700
	0.2590	0.2750		0.2620	0.2750		0.2650	0.2750
	0.2620	0.2750		0.2650	0.2750		0.2680	0.2750
	0.2605	0.2700		0.2635	0.2700		0.2665	0.2700
ga	0.2590	0.2750	gb	0.2620	0.2750	gc	0.2650	0.2750
	0.2605	0.2800		0.2635	0.2800		0.2665	0.2800
	0.2635	0.2800		0.2665	0.2800		0.2695	0.2800
	0.2620	0.2750		0.2650	0.2750		0.2680	0.2750
fa	0.2605	0.2800	fb	0.2635	0.2800	fc	0.2665	0.2800
	0.2620	0.2850		0.2650	0.2850		0.2680	0.2850
	0.2650	0.2850		0.2680	0.2850		0.2710	0.2850
	0.2635	0.2800		0.2665	0.2800		0.2695	0.2800
ea	0.2620	0.2850	eb	0.2650	0.2850	ec	0.2680	0.2850
	0.2635	0.2900		0.2665	0.2900		0.2695	0.2900
	0.2665	0.2900		0.2695	0.2900		0.2725	0.2900
	0.2650	0.2850		0.2680	0.2850		0.2710	0.2850
da	0.2635	0.2900	db	0.2665	0.2900	dc	0.2695	0.2900
	0.2650	0.2950		0.2680	0.2950		0.2710	0.2950
	0.2680	0.2950		0.2710	0.2950		0.2740	0.2950
	0.2665	0.2900		0.2695	0.2900		0.2725	0.2900
ca	0.2650	0.2950	cb	0.2680	0.2950	cc	0.2710	0.2950
	0.2665	0.3000		0.2695	0.3000		0.2725	0.3000
	0.2695	0.3000		0.2725	0.3000		0.2755	0.3000
	0.2680	0.2950		0.2710	0.2950		0.2740	0.2950

If color binning is required, only one color group is allowed for each chip within a reel.

Chromaticity coordinate groups are measured with an accuracy of ± 0.005



Solid-State Light. Done Right.

Rank	x	y	Rank	x	y	Rank	x	y
ba	0.2665	0.3000	bb	0.2695	0.3000	bc	0.2725	0.3000
	0.2680	0.3050		0.2710	0.3050		0.2740	0.3050
	0.2710	0.3050		0.2740	0.3050		0.2770	0.3050
	0.2695	0.3000		0.2725	0.3000		0.2755	0.3000
aa	0.2680	0.3050	ab	0.2710	0.3050	ac	0.2740	0.3050
	0.2695	0.3100		0.2725	0.3100		0.2755	0.3100
	0.2725	0.3100		0.2755	0.3100		0.2785	0.3100
	0.2710	0.3050		0.2740	0.3050		0.2770	0.3050
-aa	0.2695	0.3100	-ab	0.2725	0.3100	-ac	0.2755	0.3100
	0.2710	0.3150		0.2740	0.3150		0.2770	0.3150
	0.2740	0.3150		0.2770	0.3150		0.2800	0.3150
	0.2725	0.3100		0.2755	0.3100		0.2785	0.3100
-ba	0.2710	0.3150	-bb	0.2740	0.3150	-bc	0.2770	0.3150
	0.2725	0.3200		0.2755	0.3200		0.2785	0.3200
	0.2755	0.3200		0.2785	0.3200		0.2815	0.3200
	0.2740	0.3150		0.2770	0.3150		0.2800	0.3150
wd	0.2500	0.2150	we	0.2530	0.2150	wf	0.2560	0.2150
	0.2515	0.2200		0.2545	0.2200		0.2575	0.2200
	0.2545	0.2200		0.2575	0.2200		0.2605	0.2200
	0.2530	0.2150		0.2560	0.2150		0.2590	0.2150
vd	0.2515	0.2200	ve	0.2545	0.2200	vf	0.2575	0.2200
	0.2530	0.2250		0.2560	0.2250		0.2590	0.2250
	0.2560	0.2250		0.2590	0.2250		0.2620	0.2250
	0.2545	0.2200		0.2575	0.2200		0.2605	0.2200
ud	0.2530	0.2250	ue	0.2560	0.2250	uf	0.2590	0.2250
	0.2545	0.2300		0.2575	0.2300		0.2605	0.2300
	0.2575	0.2300		0.2605	0.2300		0.2635	0.2300
	0.2560	0.2250		0.2590	0.2250		0.2620	0.2250
td	0.2545	0.2300	te	0.2575	0.2300	tf	0.2605	0.2300
	0.2560	0.2350		0.2590	0.2350		0.2620	0.2350
	0.2590	0.2350		0.2620	0.2350		0.2650	0.2350
	0.2575	0.2300		0.2605	0.2300		0.2635	0.2300
sd	0.2560	0.2350	se	0.2590	0.2350	sf	0.2620	0.2350
	0.2575	0.2400		0.2605	0.2400		0.2635	0.2400
	0.2605	0.2400		0.2635	0.2400		0.2665	0.2400
	0.2590	0.2350		0.2620	0.2350		0.2650	0.2350
rd	0.2575	0.2400	re	0.2605	0.2400	rf	0.2635	0.2400
	0.2590	0.2450		0.2620	0.2450		0.2650	0.2450
	0.2620	0.2450		0.2650	0.2450		0.2680	0.2450
	0.2605	0.2400		0.2635	0.2400		0.2665	0.2400
pd	0.2590	0.2450	pe	0.2620	0.2450	pf	0.2650	0.2450
	0.2605	0.2500		0.2635	0.2500		0.2665	0.2500
	0.2635	0.2500		0.2665	0.2500		0.2695	0.2500
	0.2620	0.2450		0.2650	0.2450		0.2680	0.2450

If color binning is required, only one color group is allowed for each chip within a reel.

Chromaticity coordinate groups are measured with an accuracy of ± 0.005



Solid-State Light. Done Right.

Rank	x	y	Rank	x	y	Rank	x	y
nd	0.2605	0.2500	ne	0.2635	0.2500	nf	0.2665	0.2500
	0.2620	0.2550		0.2650	0.2550		0.2680	0.2550
	0.2650	0.2550		0.2680	0.2550		0.2710	0.2550
	0.2635	0.2500		0.2665	0.2500		0.2695	0.2500
md	0.2620	0.2550	me	0.2650	0.2550	mf	0.2680	0.2550
	0.2635	0.2600		0.2665	0.2600		0.2695	0.2600
	0.2665	0.2600		0.2695	0.2600		0.2725	0.2600
	0.2650	0.2550		0.2680	0.2550		0.2710	0.2550
kd	0.2635	0.2600	ke	0.2665	0.2600	kf	0.2695	0.2600
	0.2650	0.2650		0.2680	0.2650		0.2710	0.2650
	0.2680	0.2650		0.2710	0.2650		0.2740	0.2650
	0.2665	0.2600		0.2695	0.2600		0.2725	0.2600
jd	0.2650	0.2650	je	0.2680	0.2650	jf	0.2710	0.2650
	0.2665	0.2700		0.2695	0.2700		0.2725	0.2700
	0.2695	0.2700		0.2725	0.2700		0.2755	0.2700
	0.2680	0.2650		0.2710	0.2650		0.2740	0.2650
hd	0.2665	0.2700	he	0.2695	0.2700	hf	0.2725	0.2700
	0.2680	0.2750		0.2710	0.2750		0.2740	0.2750
	0.2710	0.2750		0.2740	0.2750		0.2770	0.2750
	0.2695	0.2700		0.2725	0.2700		0.2755	0.2700
gd	0.2680	0.2750	ge	0.2710	0.2750	gf	0.2740	0.2750
	0.2695	0.2800		0.2725	0.2800		0.2755	0.2800
	0.2725	0.2800		0.2755	0.2800		0.2785	0.2800
	0.2710	0.2750		0.2740	0.2750		0.2770	0.2750
fd	0.2695	0.2800	fe	0.2725	0.2800	ff	0.2755	0.2800
	0.2710	0.2850		0.2740	0.2850		0.2770	0.2850
	0.2740	0.2850		0.2770	0.2850		0.2800	0.2850
	0.2725	0.2800		0.2755	0.2800		0.2785	0.2800
ed	0.2710	0.2850	ee	0.2740	0.2850	ef	0.2770	0.2850
	0.2725	0.2900		0.2755	0.2900		0.2785	0.2900
	0.2755	0.2900		0.2785	0.2900		0.2815	0.2900
	0.2740	0.2850		0.2770	0.2850		0.2800	0.2850
dd	0.2725	0.2900	de	0.2755	0.2900	df	0.2785	0.2900
	0.2740	0.2950		0.2770	0.2950		0.2800	0.2950
	0.2770	0.2950		0.2800	0.2950		0.2830	0.2950
	0.2755	0.2900		0.2785	0.2900		0.2815	0.2900
cd	0.2740	0.2950	ce	0.2770	0.2950	cf	0.2800	0.2950
	0.2755	0.3000		0.2785	0.3000		0.2815	0.3000
	0.2785	0.3000		0.2815	0.3000		0.2845	0.3000
	0.2770	0.2950		0.2800	0.2950		0.2830	0.2950
bd	0.2755	0.3000	be	0.2785	0.3000	bf	0.2815	0.3000
	0.2770	0.3050		0.2800	0.3050		0.2830	0.3050
	0.2800	0.3050		0.2830	0.3050		0.2860	0.3050
	0.2785	0.3000		0.2815	0.3000		0.2845	0.3000

If color binning is required, only one color group is allowed for each chip within a reel.

Chromaticity coordinate groups are measured with an accuracy of ± 0.005



Solid-State Light. Done Right.

Rank	x	y	Rank	x	y	Rank	x	y
ad	0.2770	0.3050	ae	0.2800	0.3050	af	0.2830	0.3050
	0.2785	0.3100		0.2815	0.3100		0.2845	0.3100
	0.2815	0.3100		0.2845	0.3100		0.2875	0.3100
	0.2800	0.3050		0.2830	0.3050		0.2860	0.3050
-ad	0.2785	0.3100	-ae	0.2815	0.3100	-af	0.2845	0.3100
	0.2800	0.3150		0.2830	0.3150		0.2860	0.3150
	0.2830	0.3150		0.2860	0.3150		0.2890	0.3150
	0.2815	0.3100		0.2845	0.3100		0.2875	0.3100
-bd	0.2800	0.3150	-be	0.2830	0.3150	-bf	0.2860	0.3150
	0.2815	0.3200		0.2845	0.3200		0.2875	0.3200
	0.2845	0.3200		0.2875	0.3200		0.2905	0.3200
	0.2830	0.3150		0.2860	0.3150		0.2890	0.3150
wg	0.2590	0.2150	wh	0.2620	0.2150	wj	0.2650	0.2150
	0.2605	0.2200		0.2635	0.2200		0.2665	0.2200
	0.2635	0.2200		0.2665	0.2200		0.2695	0.2200
	0.2620	0.2150		0.2650	0.2150		0.2680	0.2150
vg	0.2605	0.2200	vh	0.2635	0.2200	vj	0.2665	0.2200
	0.2620	0.2250		0.2650	0.2250		0.2680	0.2250
	0.2650	0.2250		0.2680	0.2250		0.2710	0.2250
	0.2635	0.2200		0.2665	0.2200		0.2695	0.2200
ug	0.2620	0.2250	uh	0.2650	0.2250	uj	0.2680	0.2250
	0.2635	0.2300		0.2665	0.2300		0.2695	0.2300
	0.2665	0.2300		0.2695	0.2300		0.2725	0.2300
	0.2650	0.2250		0.2680	0.2250		0.2710	0.2250
tg	0.2635	0.2300	th	0.2665	0.2300	tj	0.2695	0.2300
	0.2650	0.2350		0.2680	0.2350		0.2710	0.2350
	0.2680	0.2350		0.2710	0.2350		0.2740	0.2350
	0.2665	0.2300		0.2695	0.2300		0.2725	0.2300
sg	0.2650	0.2350	sh	0.2680	0.2350	sj	0.2710	0.2350
	0.2665	0.2400		0.2695	0.2400		0.2725	0.2400
	0.2695	0.2400		0.2725	0.2400		0.2755	0.2400
	0.2680	0.2350		0.2710	0.2350		0.2740	0.2350
rg	0.2665	0.2400	rh	0.2695	0.2400	rj	0.2725	0.2400
	0.2680	0.2450		0.2710	0.2450		0.2740	0.2450
	0.2710	0.2450		0.2740	0.2450		0.2770	0.2450
	0.2695	0.2400		0.2725	0.2400		0.2755	0.2400
pg	0.2680	0.2450	ph	0.2710	0.2450	pj	0.2740	0.2450
	0.2695	0.2500		0.2725	0.2500		0.2755	0.2500
	0.2725	0.2500		0.2755	0.2500		0.2785	0.2500
	0.2710	0.2450		0.2740	0.2450		0.2770	0.2450
ng	0.2695	0.2500	nh	0.2725	0.2500	nj	0.2755	0.2500
	0.2710	0.2550		0.2740	0.2550		0.2770	0.2550
	0.2740	0.2550		0.2770	0.2550		0.2800	0.2550
	0.2725	0.2500		0.2755	0.2500		0.2785	0.2500

If color binning is required, only one color group is allowed for each chip within a reel.

Chromaticity coordinate groups are measured with an accuracy of ± 0.005



Solid-State Light. Done Right.

Rank	x	y	Rank	x	y	Rank	x	y
mg	0.2710	0.2550	mh	0.2740	0.2550	mj	0.2770	0.2550
	0.2725	0.2600		0.2755	0.2600		0.2785	0.2600
	0.2755	0.2600		0.2785	0.2600		0.2815	0.2600
	0.2740	0.2550		0.2770	0.2550		0.2800	0.2550
kg	0.2725	0.2600	kh	0.2755	0.2600	kj	0.2785	0.2600
	0.2740	0.2650		0.2770	0.2650		0.2800	0.2650
	0.2770	0.2650		0.2800	0.2650		0.2830	0.2650
	0.2755	0.2600		0.2785	0.2600		0.2815	0.2600
jg	0.2740	0.2650	jh	0.2770	0.2650	jj	0.2800	0.2650
	0.2755	0.2700		0.2785	0.2700		0.2815	0.2700
	0.2785	0.2700		0.2815	0.2700		0.2845	0.2700
	0.2770	0.2650		0.2800	0.2650		0.2830	0.2650
hg	0.2755	0.2700	hh	0.2785	0.2700	hj	0.2815	0.2700
	0.2770	0.2750		0.2800	0.2750		0.2830	0.2750
	0.2800	0.2750		0.2830	0.2750		0.2860	0.2750
	0.2785	0.2700		0.2815	0.2700		0.2845	0.2700
gg	0.2770	0.2750	gh	0.2800	0.2750	gj	0.2830	0.2750
	0.2785	0.2800		0.2815	0.2800		0.2845	0.2800
	0.2815	0.2800		0.2845	0.2800		0.2875	0.2800
	0.2800	0.2750		0.2830	0.2750		0.2860	0.2750
fg	0.2785	0.2800	fh	0.2815	0.2800	fj	0.2845	0.2800
	0.2800	0.2850		0.2830	0.2850		0.2860	0.2850
	0.2830	0.2850		0.2860	0.2850		0.2890	0.2850
	0.2815	0.2800		0.2845	0.2800		0.2875	0.2800
eg	0.2800	0.2850	eh	0.2830	0.2850	ej	0.2860	0.2850
	0.2815	0.2900		0.2845	0.2900		0.2875	0.2900
	0.2845	0.2900		0.2875	0.2900		0.2905	0.2900
	0.2830	0.2850		0.2860	0.2850		0.2890	0.2850
dg	0.2815	0.2900	dh	0.2845	0.2900	dj	0.2875	0.2900
	0.2830	0.2950		0.2860	0.2950		0.2890	0.2950
	0.2860	0.2950		0.2890	0.2950		0.2920	0.2950
	0.2845	0.2900		0.2875	0.2900		0.2905	0.2900
cg	0.2830	0.2950	ch	0.2860	0.2950	cj	0.2890	0.2950
	0.2845	0.3000		0.2875	0.3000		0.2905	0.3000
	0.2875	0.3000		0.2905	0.3000		0.2935	0.3000
	0.2860	0.2950		0.2890	0.2950		0.2920	0.2950
bg	0.2845	0.3000	bh	0.2875	0.3000	bj	0.2905	0.3000
	0.2860	0.3050		0.2890	0.3050		0.2920	0.3050
	0.2890	0.3050		0.2920	0.3050		0.2950	0.3050
	0.2875	0.3000		0.2905	0.3000		0.2935	0.3000
ag	0.2860	0.3050	ah	0.2890	0.3050	aj	0.2920	0.3050
	0.2875	0.3100		0.2905	0.3100		0.2935	0.3100
	0.2905	0.3100		0.2935	0.3100		0.2965	0.3100
	0.2890	0.3050		0.2920	0.3050		0.2950	0.3050

If color binning is required, only one color group is allowed for each chip within a reel.

Chromaticity coordinate groups are measured with an accuracy of ± 0.005



Solid-State Light. Done Right.

Rank	x	y	Rank	x	y	Rank	x	y
-ag	0.2875	0.3100	-ah	0.2905	0.3100	-aj	0.2935	0.3100
	0.2890	0.3150		0.2920	0.3150		0.2950	0.3150
	0.2920	0.3150		0.2950	0.3150		0.2980	0.3150
	0.2905	0.3100		0.2935	0.3100		0.2965	0.3100
-bg	0.2890	0.3150	-bh	0.2920	0.3150	-bj	0.2950	0.3150
	0.2905	0.3200		0.2935	0.3200		0.2965	0.3200
	0.2935	0.3200		0.2965	0.3200		0.2995	0.3200
	0.2920	0.3150		0.2950	0.3150		0.2980	0.3150
wk	0.2680	0.2150	wm	0.2710	0.2150	wn	0.2740	0.2150
	0.2695	0.2200		0.2725	0.2200		0.2755	0.2200
	0.2725	0.2200		0.2755	0.2200		0.2784	0.2200
	0.2710	0.2150		0.2740	0.2150		0.2770	0.2150
vk	0.2695	0.2200	vm	0.2725	0.2200	vn	0.2755	0.2200
	0.2710	0.2250		0.2740	0.2250		0.2770	0.2250
	0.2740	0.2250		0.2770	0.2250		0.2800	0.2250
	0.2725	0.2200		0.2755	0.2200		0.2785	0.2200
uk	0.2710	0.2250	um	0.2740	0.2250	un	0.2770	0.2250
	0.2725	0.2300		0.2755	0.2300		0.2785	0.2300
	0.2755	0.2300		0.2785	0.2300		0.2815	0.2300
	0.2740	0.2250		0.2770	0.2250		0.2800	0.2250
tk	0.2725	0.2300	tm	0.2755	0.2300	tn	0.2785	0.2300
	0.2740	0.2350		0.2770	0.2350		0.2800	0.2350
	0.2770	0.2350		0.2800	0.2350		0.2830	0.2350
	0.2755	0.2300		0.2785	0.2300		0.2815	0.2300
sk	0.2740	0.2350	sm	0.2770	0.2350	sn	0.2800	0.2350
	0.2755	0.2400		0.2785	0.2400		0.2815	0.2400
	0.2785	0.2400		0.2815	0.2400		0.2845	0.2400
	0.2770	0.2350		0.2800	0.2350		0.2830	0.2350
rk	0.2755	0.2400	rm	0.2785	0.2400	rn	0.2815	0.2400
	0.2770	0.2450		0.2800	0.2450		0.2830	0.2450
	0.2800	0.2450		0.2830	0.2450		0.2860	0.2450
	0.2785	0.2400		0.2815	0.2400		0.2845	0.2400
pk	0.2770	0.2450	pm	0.2800	0.2450	pn	0.2830	0.2450
	0.2785	0.2500		0.2815	0.2500		0.2845	0.2500
	0.2815	0.2500		0.2845	0.2500		0.2875	0.2500
	0.2800	0.2450		0.2830	0.2450		0.2860	0.2450
nk	0.2785	0.2500	nm	0.2815	0.2500	nn	0.2845	0.2500
	0.2800	0.2550		0.2830	0.2550		0.2860	0.2550
	0.2830	0.2550		0.2860	0.2550		0.2890	0.2550
	0.2815	0.2500		0.2845	0.2500		0.2875	0.2500
mk	0.2800	0.2550	mm	0.2830	0.2550	mn	0.2860	0.2550
	0.2815	0.2600		0.2845	0.2600		0.2875	0.2600
	0.2845	0.2600		0.2875	0.2600		0.2905	0.2600
	0.2830	0.2550		0.2860	0.2550		0.2890	0.2550

If color binning is required, only one color group is allowed for each chip within a reel.

Chromaticity coordinate groups are measured with an accuracy of ± 0.005



Solid-State Light. Done Right.

Rank	x	y	Rank	x	y	Rank	x	y
kk	0.2815	0.2600	km	0.2845	0.2600	kn	0.2875	0.2600
	0.2830	0.2650		0.2860	0.2650		0.2890	0.2650
	0.2860	0.2650		0.2890	0.2650		0.2920	0.2650
	0.2845	0.2600		0.2875	0.2600		0.2905	0.2600
jk	0.2830	0.2650	jm	0.2860	0.2650	jn	0.2890	0.2650
	0.2845	0.2700		0.2875	0.2700		0.2905	0.2700
	0.2875	0.2700		0.2905	0.2700		0.2935	0.2700
	0.2860	0.2650		0.2890	0.2650		0.2920	0.2650
hk	0.2845	0.2700	hm	0.2875	0.2700	hn	0.2905	0.2700
	0.2860	0.2750		0.2890	0.2750		0.2920	0.2750
	0.2890	0.2750		0.2920	0.2750		0.2950	0.2750
	0.2875	0.2700		0.2905	0.2700		0.2935	0.2700
gk	0.2860	0.2750	gm	0.2890	0.2750	gn	0.2920	0.2750
	0.2875	0.2800		0.2905	0.2800		0.2935	0.2800
	0.2905	0.2800		0.2935	0.2800		0.2965	0.2800
	0.2890	0.2750		0.2920	0.2750		0.2950	0.2750
fk	0.2875	0.2800	fm	0.2905	0.2800	fn	0.2935	0.2800
	0.2890	0.2850		0.2920	0.2850		0.2950	0.2850
	0.2920	0.2850		0.2950	0.2850		0.2980	0.2850
	0.2905	0.2800		0.2935	0.2800		0.2965	0.2800
ek	0.2890	0.2850	em	0.2920	0.2850	en	0.2950	0.2850
	0.2905	0.2900		0.2935	0.2900		0.2965	0.2900
	0.2935	0.2900		0.2965	0.2900		0.2995	0.2900
	0.2920	0.2850		0.2950	0.2850		0.2980	0.2850
dk	0.2905	0.2900	dm	0.2935	0.2900	dn	0.2965	0.2900
	0.2920	0.2950		0.2950	0.2950		0.2980	0.2950
	0.2950	0.2950		0.2980	0.2950		0.3010	0.2950
	0.2935	0.2900		0.2965	0.2900		0.2995	0.2900
ck	0.2920	0.2950	cm	0.2950	0.2950	cn	0.2980	0.2950
	0.2935	0.3000		0.2965	0.3000		0.2995	0.3000
	0.2965	0.3000		0.2995	0.3000		0.3025	0.3000
	0.2950	0.2950		0.2980	0.2950		0.3010	0.2950
bk	0.2935	0.3000	bm	0.2965	0.3000	bn	0.2995	0.3000
	0.2950	0.3050		0.2980	0.3050		0.3010	0.3050
	0.2980	0.3050		0.3010	0.3050		0.3040	0.3050
	0.2965	0.3000		0.2995	0.3000		0.3025	0.3000
ak	0.2950	0.3050	am	0.2980	0.3050	an	0.3010	0.3050
	0.2965	0.3100		0.2995	0.3100		0.3025	0.3100
	0.2995	0.3100		0.3025	0.3100		0.3055	0.3100
	0.2980	0.3050		0.3010	0.3050		0.3040	0.3050
-ak	0.2965	0.3100	-am	0.2995	0.3100	-an	0.3025	0.3100
	0.2980	0.3150		0.3010	0.3150		0.3040	0.3150
	0.3010	0.3150		0.3040	0.3150		0.3070	0.3150
	0.2995	0.3100		0.3025	0.3100		0.3055	0.3100

If color binning is required, only one color group is allowed for each chip within a reel.

Chromaticity coordinate groups are measured with an accuracy of ± 0.005



Solid-State Light. Done Right.

Rank	x	y	Rank	x	y	Rank	x	y
-bk	0.2980	0.3150	-bm	0.3010	0.3150	-bn	0.3040	0.3150
	0.2995	0.3200		0.3025	0.3200		0.3055	0.3200
	0.3025	0.3200		0.3055	0.3200		0.3085	0.3200
	0.3010	0.3150		0.3040	0.3150		0.3070	0.3150
wp	0.2770	0.2150	wr	0.2800	0.2150			
	0.2785	0.2200		0.2815	0.2200			
	0.2815	0.2200		0.2845	0.2200			
	0.2800	0.2150		0.2830	0.2150			
vp	0.2785	0.2200	vr	0.2815	0.2200			
	0.2800	0.2250		0.2830	0.2250			
	0.2830	0.2250		0.2860	0.2250			
	0.2815	0.2200		0.2845	0.2200			
up	0.2800	0.2250	ur	0.2830	0.2250			
	0.2815	0.2300		0.2845	0.2300			
	0.2845	0.2300		0.2875	0.2300			
	0.2830	0.2250		0.2860	0.2250			
tp	0.2815	0.2300	tr	0.2845	0.2300			
	0.2830	0.2350		0.2860	0.2350			
	0.2860	0.2350		0.2890	0.2350			
	0.2845	0.2300		0.2875	0.2300			
sp	0.2830	0.2350	sr	0.2860	0.2350			
	0.2845	0.2400		0.2875	0.2400			
	0.2875	0.2400		0.2905	0.2400			
	0.2860	0.2350		0.2890	0.2350			
rp	0.2845	0.2400	rr	0.2875	0.2400			
	0.2860	0.2450		0.2890	0.2450			
	0.2890	0.2450		0.2920	0.2450			
	0.2875	0.2400		0.2905	0.2400			
pp	0.2860	0.2450	pr	0.2890	0.2450			
	0.2875	0.2500		0.2905	0.2500			
	0.2905	0.2500		0.2935	0.2500			
	0.2890	0.2450		0.2920	0.2450			
np	0.2875	0.2500	nr	0.2905	0.2500			
	0.2890	0.2550		0.2920	0.2550			
	0.2920	0.2550		0.2950	0.2550			
	0.2905	0.2500		0.2935	0.2500			
mp	0.2890	0.2550	mr	0.2920	0.2550			
	0.2905	0.2600		0.2935	0.2600			
	0.2935	0.2600		0.2965	0.2600			
	0.2920	0.2550		0.2950	0.2550			
kp	0.2905	0.2600	kr	0.2935	0.2600			
	0.2920	0.2650		0.2950	0.2650			
	0.2950	0.2650		0.2980	0.2650			
	0.2935	0.2600		0.2965	0.2600			

If color binning is required, only one color group is allowed for each chip within a reel.

Chromaticity coordinate groups are measured with an accuracy of ± 0.005



Solid-State Light. Done Right.

Rank	x	y	Rank	x	y	Rank	x	y
jp	0.2920	0.2650	jr	0.2950	0.2650			
	0.2935	0.2700		0.2965	0.2700			
	0.2965	0.2700		0.2995	0.2700			
	0.2950	0.2650		0.2980	0.2650			
hp	0.2935	0.2700	hr	0.2965	0.2700			
	0.2950	0.2750		0.2980	0.2750			
	0.2980	0.2750		0.3010	0.2750			
	0.2965	0.2700		0.2995	0.2700			
gp	0.2950	0.2750	gr	0.2980	0.2750			
	0.2965	0.2800		0.2995	0.2800			
	0.2995	0.2800		0.3025	0.2800			
	0.2980	0.2750		0.3010	0.2750			
fp	0.2965	0.2800	fr	0.2995	0.2800			
	0.2980	0.2850		0.3010	0.2850			
	0.3010	0.2850		0.3040	0.2850			
	0.2995	0.2800		0.3025	0.2800			
ep	0.2980	0.2850	er	0.3010	0.2850			
	0.2995	0.2900		0.3025	0.2900			
	0.3025	0.2900		0.3055	0.2900			
	0.3010	0.2850		0.3040	0.2850			
dp	0.2995	0.2900	dr	0.3025	0.2900			
	0.3010	0.2950		0.3040	0.2950			
	0.3040	0.2950		0.3070	0.2950			
	0.3025	0.2900		0.3055	0.2900			
cp	0.3010	0.2950	cr	0.3040	0.2950			
	0.3025	0.3000		0.3055	0.3000			
	0.3055	0.3000		0.3085	0.3000			
	0.3040	0.2950		0.3070	0.2950			
bp	0.3025	0.3000	br	0.3055	0.3000			
	0.3040	0.3050		0.3070	0.3050			
	0.3070	0.3050		0.3100	0.3050			
	0.3055	0.3000		0.3085	0.3000			
ap	0.3040	0.3050	ar	0.3070	0.3050			
	0.3055	0.3100		0.3085	0.3100			
	0.3085	0.3100		0.3115	0.3100			
	0.3070	0.3050		0.3100	0.3050			
-ap	0.3055	0.3100	-ar	0.3085	0.3100			
	0.3070	0.3150		0.3100	0.3150			
	0.3100	0.3150		0.3130	0.3150			
	0.3085	0.3100		0.3115	0.3100			
-bp	0.3070	0.3150	-br	0.3100	0.3150			
	0.3085	0.3200		0.3115	0.3200			
	0.3115	0.3200		0.3145	0.3200			
	0.3100	0.3150		0.3130	0.3150			

If color binning is required, only one color group is allowed for each chip within a reel.
 Chromaticity coordinate groups are measured with an accuracy of ± 0.005

Optical and electrical characteristics

Forward Voltage vs. Forward Current ($T_A=25^\circ\text{C}$)

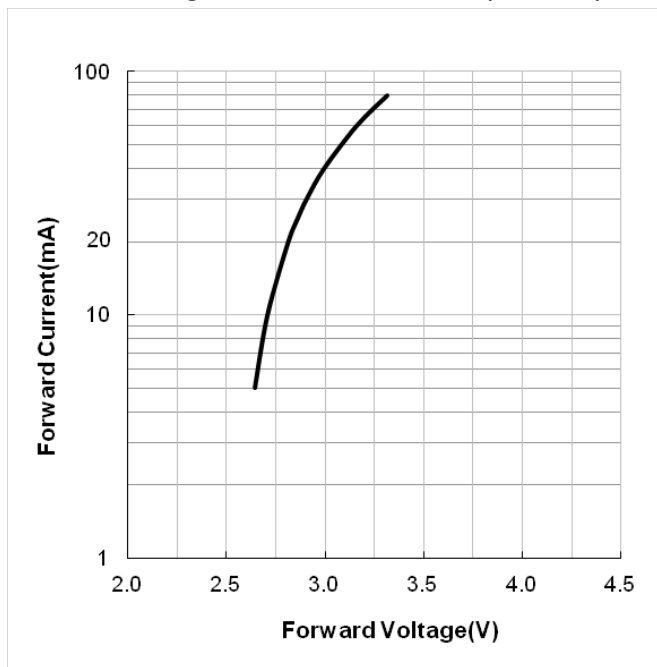

Forward Current vs. Relative Luminous Flux

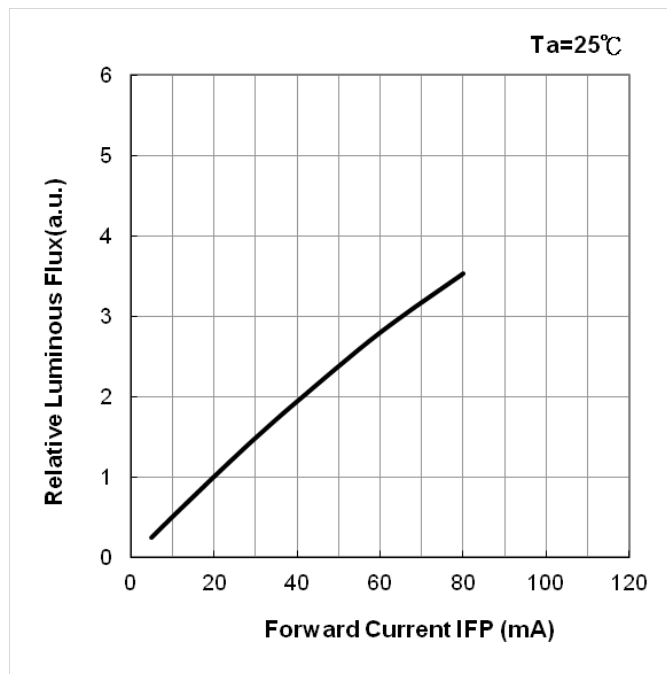

Ambient Temperature vs. Forward Voltage

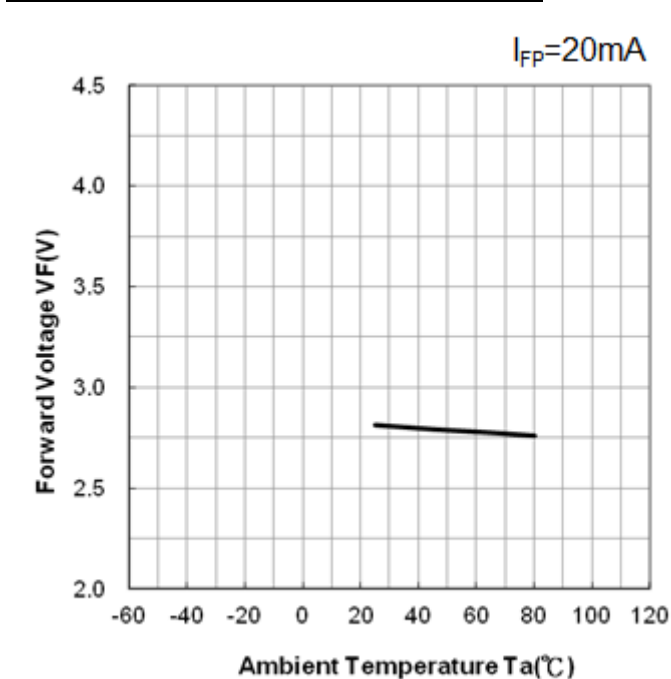

Ambient Temperature vs. Relative Luminous

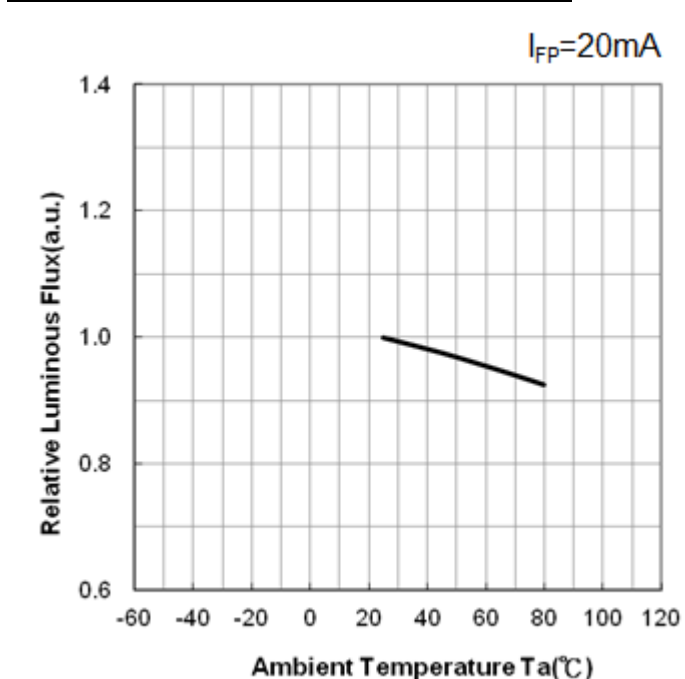

Forward Current vs. Chromaticity Coordinate ($T_A = 25^\circ\text{C}$)

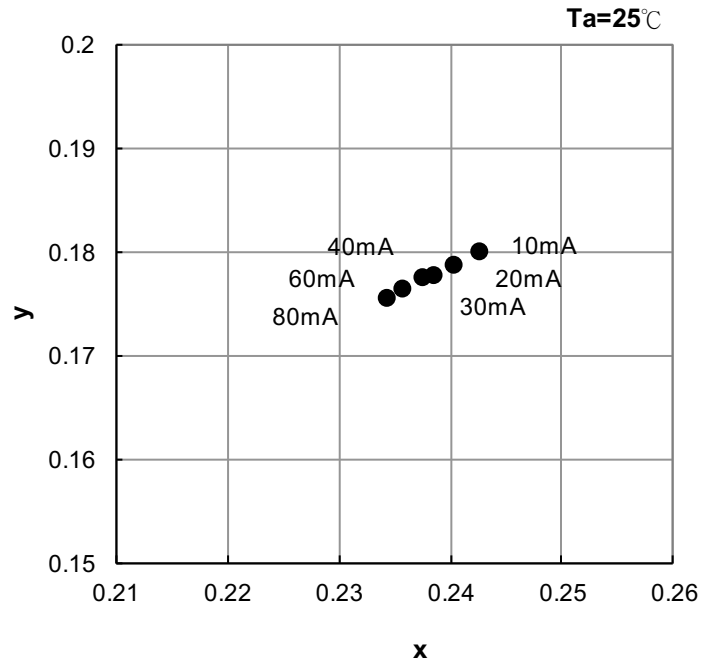

Ambient Temperature vs. Chromaticity Coordinate ($I_{FP} = 20\text{mA}$)

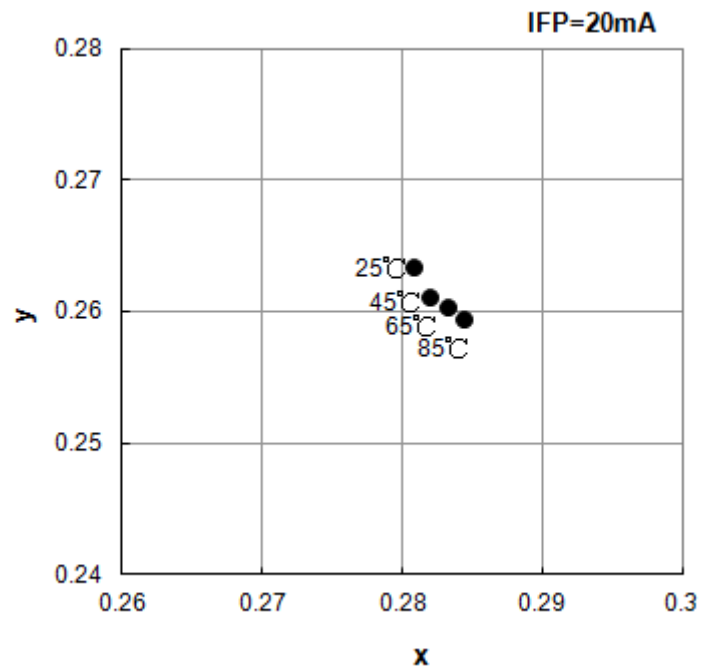

Spectrum ($T_A=25^\circ\text{C}$, $I_{FP}=20\text{mA}$)

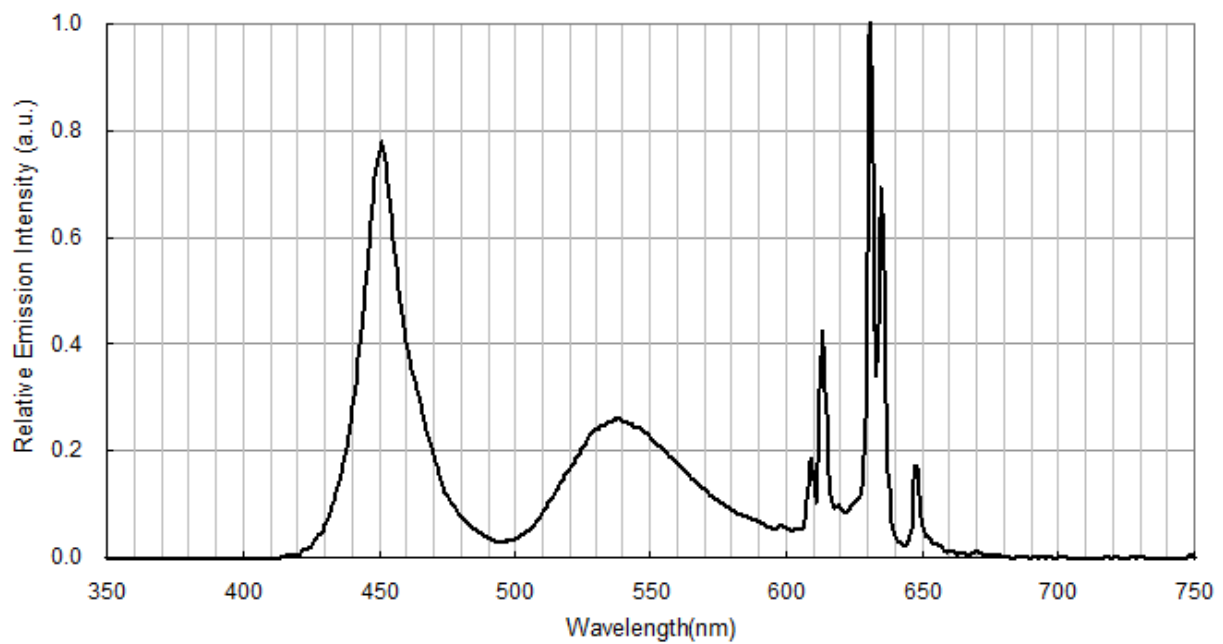

Radiation Pattern ($T_A=25^\circ\text{C}$, $I_{FP}=20\text{mA}$)

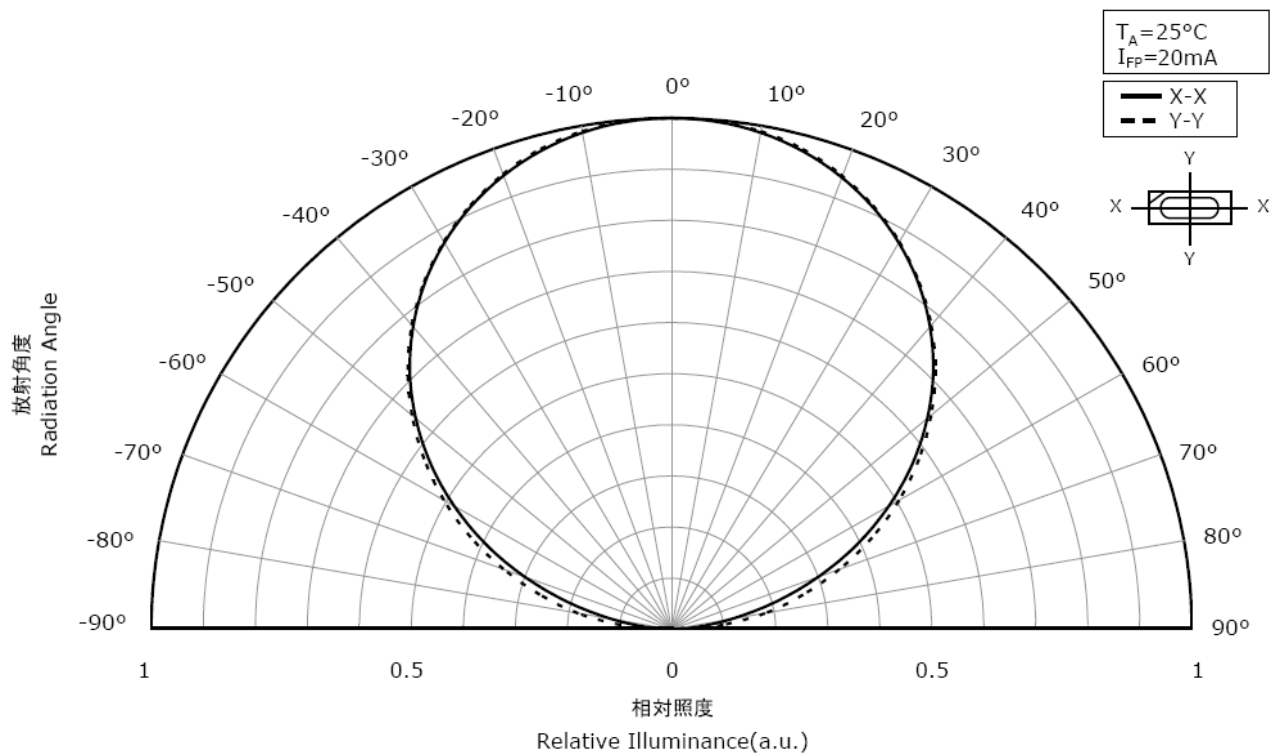

Recommended Reflow Soldering Conditions

Surface Mounting Condition

In automatic mounting of the SMD LEDs on printed circuit boards, any bending, expanding and pulling forces or shock against the SMD LEDs should be kept min. to prevent them from electrical failures and mechanical damages of the devices.

Soldering Reflow

- Soldering of the SMD LEDs should conform to the soldering condition in the individual specifications.
- SMD LEDs are designed for Reflow Soldering.
- In the reflow soldering, too high temperature and too large temperature gradient such as rapid heating/cooling may cause electrical & optical failures and damages of the devices.
- AOT cannot guarantee the LEDs after they have been assembled using the solder dipping method.

1) Lead Solder

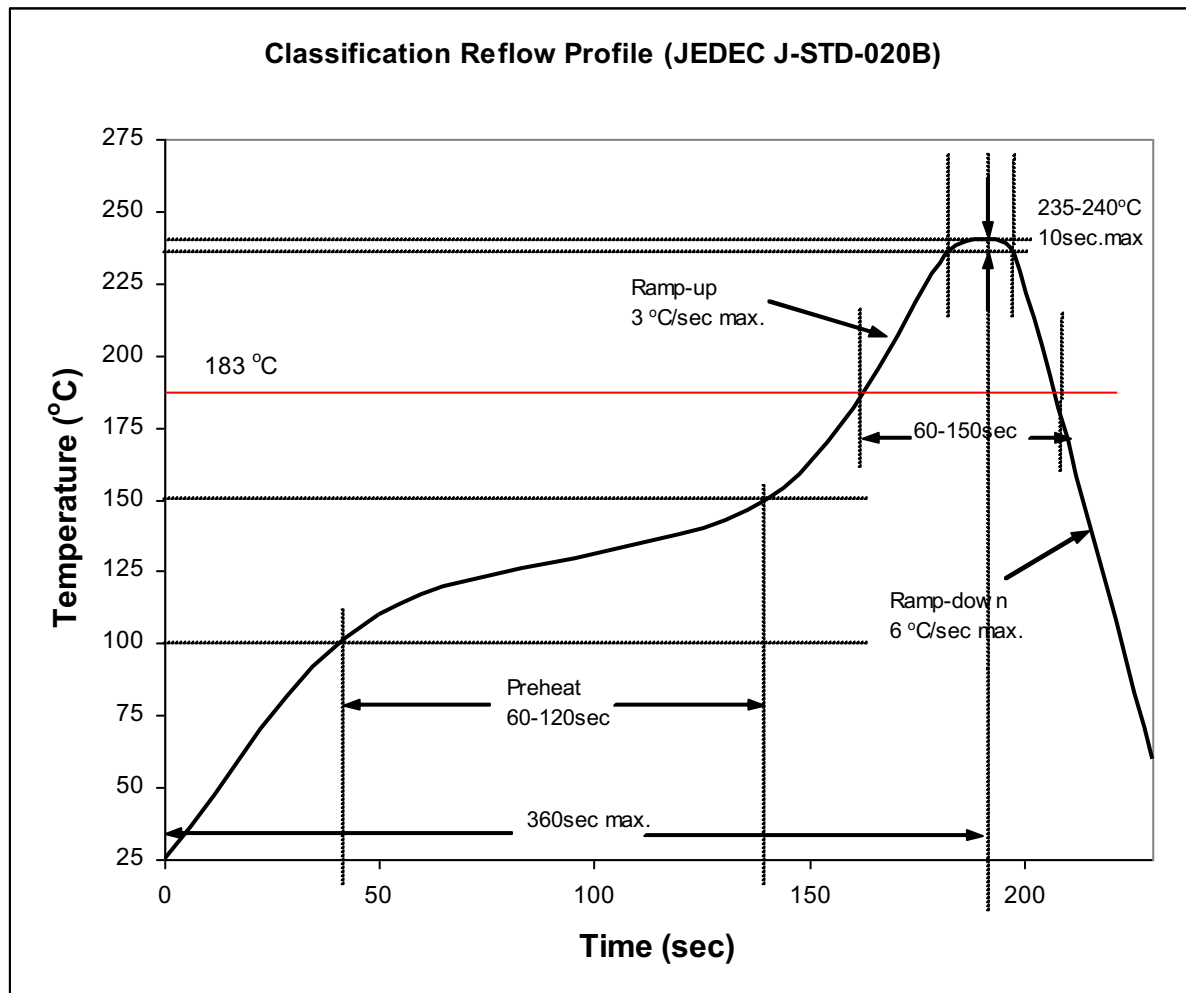

2) Lead-Free Solder

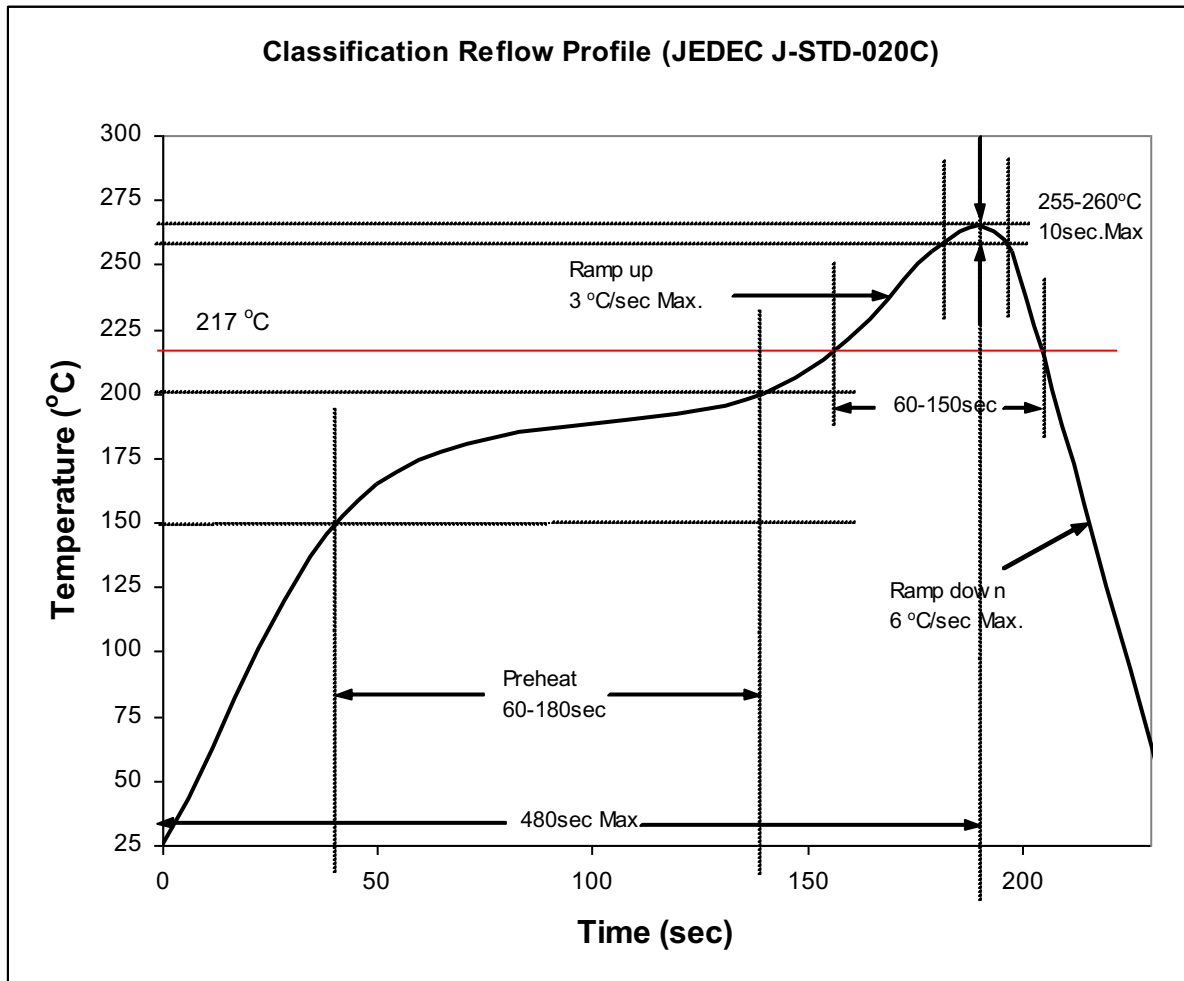

3) Manual Soldering Conditions

- Lead Solder

Max. 300 °C for Max. 3sec, and only one time.

- Lead-free Solder

Max. 350 °C for Max. 3sec, and only one time.

- There is possibility that the brightness of LEDs is decreased, which is influenced by heat or ambient atmosphere during reflow. It is recommended to use the nitrogen reflow method.
- After LEDs have been soldered, repair should not be done. As repair is unavoidable, a double-head soldering iron should be used. It should be confirmed beforehand whether the characteristics of the LEDs will be damaged by repairing or not.
- Reflow soldering should not be done more than two times.

Dimensions (Unit :mm)

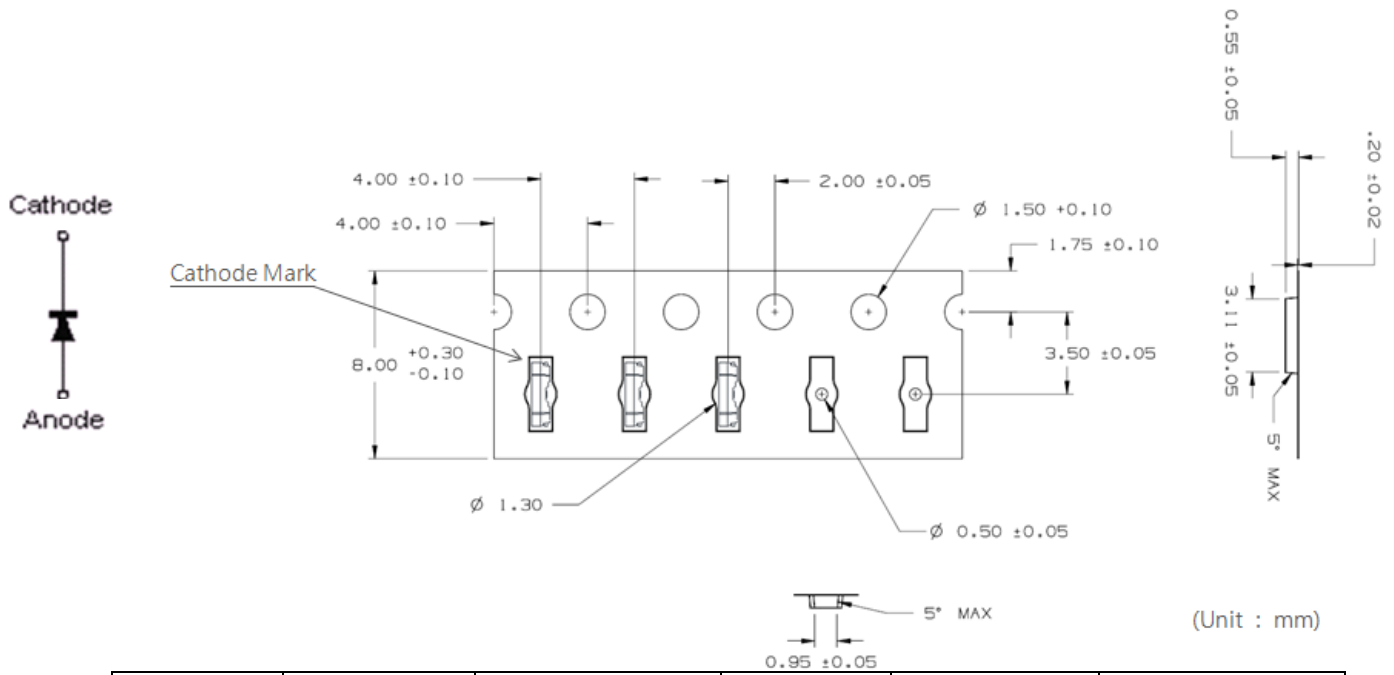

(Unit : mm)

Item	Spec.	Tolerance(mm)	Item	Spec.	Tolerance(mm)
W	8.00	+0.3/-0.1	P2	2.00	±0.05
E	1.75	±0.10	P0x10	40.0	-
F	3.50	±0.05	t	0.20	±0.05
D0	1.50	+0.10/-0.00	A0	0.95	±0.05
D1	0.5	+0.05/-0.00	B0	3.11	±0.05
P0	4.00	±0.10	K0	0.55	±0.05
P1	2.00	±0.05			

Packing Formation

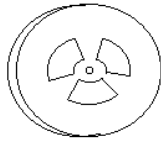

Diameter : 178 mm
Width : 8 mm
3004C-W30Q
⇒ 4,000 pcs/Reel

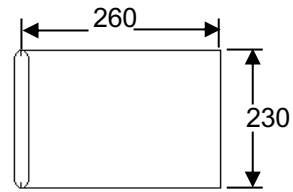
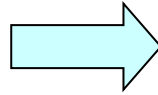

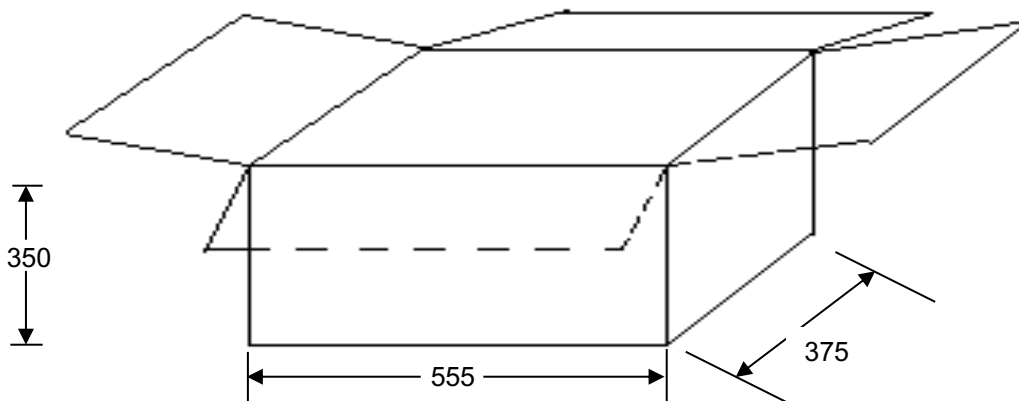
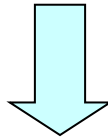

Aluminum Bag, Anti-Static Shielding
1 Reel / Bag (T = 0.1 mm)



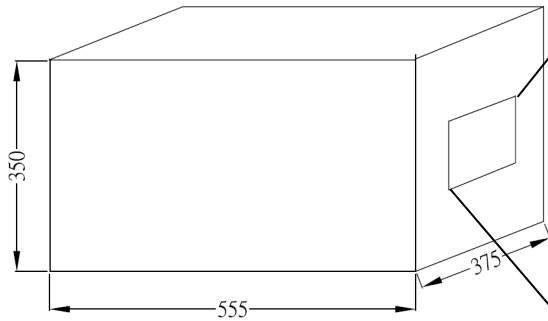

Package Outlook:



 Solid-State Light. Done Right. Advanced Optoelectronic Technology Inc.	
Customer	
PO No.	
Part No.	
Quantity	
Packing Date	
Carton No.	
Ship No.	
QC Check	 
備註	

Reel Label Definition

SMD LED Part Number : XXXXX-XXXX Brightness : A CIE : B VF : C Quantity : nn ea Serial No : SM0yymmddxxxx  Cust. PN. : XXXXX-XXXX	SAP. No.  
--	---

- A : Iv value
- B : CIE value **noted**,
- C : Vf value,
- nn : Quantity of LED

SM0yymmddxxxx : yy : year, mm : month, dd : day, xxxx : reel no

*Reel Label to fill in practice data of all LED characteristic

Reliability Test

No.	Test Item	Standard Test Method	Test Condition	Note	Number of Damaged
1	Room Temp. Life Test	Internal Ref.	$T_A=25^{\circ}\text{C}, I_F=20\text{mA}$	1000hrs	0/20
2	High Temp. Storage	JESD22-A103	$T_A=100^{\circ}\text{C}$	1000hrs	0/20
3	High Temp. Operating	JESD22-A108	$T_A=65^{\circ}\text{C}, I_F=20\text{mA}$	1000hrs	0/20
4	Low Temp. Operating	JESD22-A108	$T_A=-40^{\circ}\text{C}, I_F=20\text{mA}$	1000hrs	0/20
5	High Temp. and High Humidity Operation	JESD22-A119	$60^{\circ}\text{C } 90\%\text{RH}, I_F=20\text{mA}$	1000hrs	0/20
6	Thermal Cycle Test	JESD22-A106	$100^{\circ}\text{C } 30\text{min} \sim -40^{\circ}\text{C } 30\text{min}$ Transform time 5min	300cycles	0/200
7	Reflow Test	Internal Ref.	Reflow 260°C → HTOL $140^{\circ}\text{C } 2\text{min}$	2 cycles	0/500

Criteria for Judging Damage

Item	Symbol	Test Conditions	Criteria for Judgement	
			Min.	Max.
Forward Voltage	V_F	$I_F=20\text{mA}$	-	*U.S.L×1.1
Reverse Current	I_R	$V_R=5\text{V}$	-	*U.S.L×2.0
Luminous Intensity	I_v	$I_F=20\text{mA}$	*L.S.L×0.7	-

* U.S.L: Upper Standard Level

* L.S.L: Lower Standard Level

Side View Process Flow

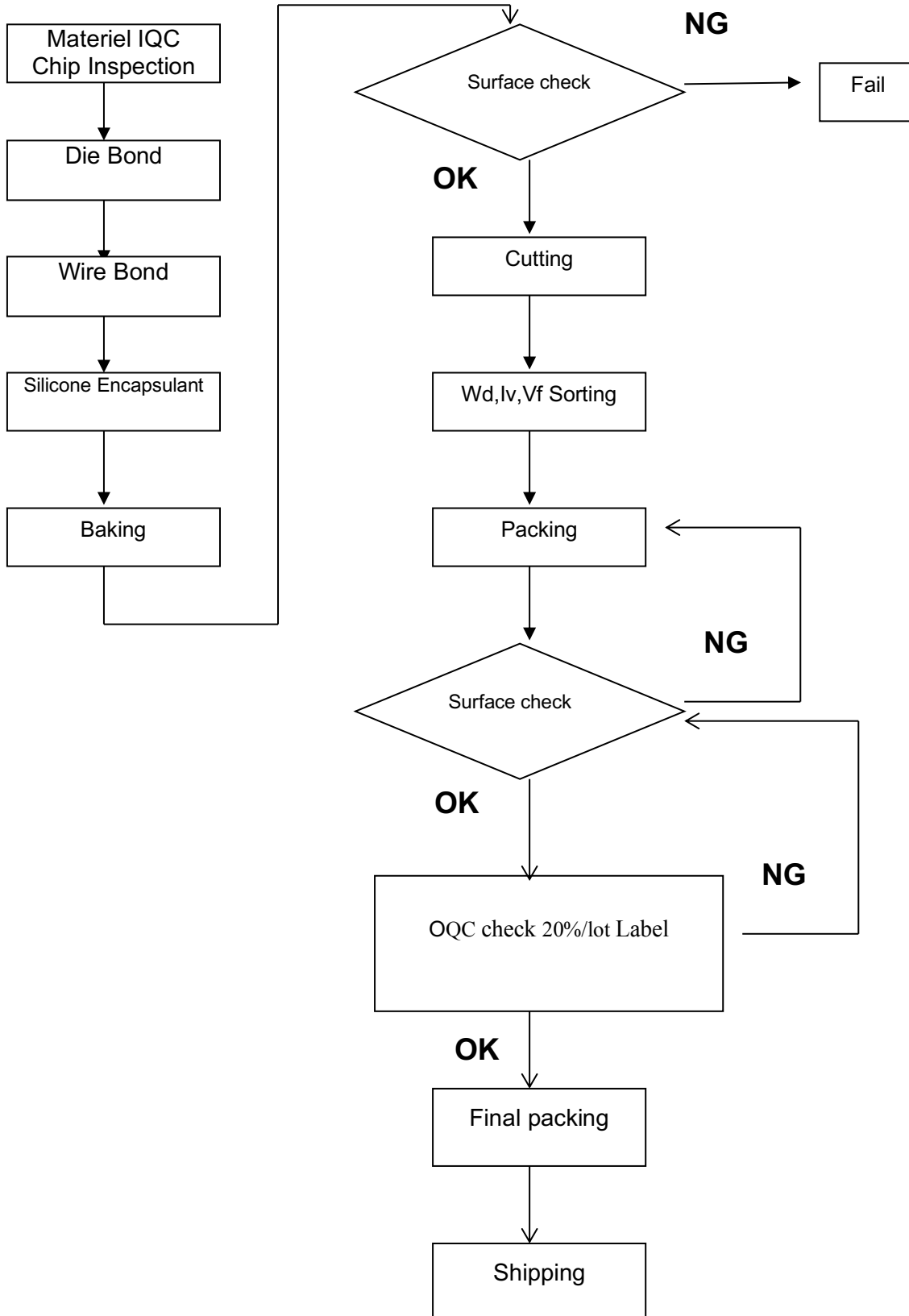

CAUTIONS

(1) Moisture Proof Package

The moisture proof package should be used to prevent moisture in the package as the moisture may Cause damage to optical characteristics of the LEDs.

The aluminum bag with zipper is used for moisture proof package. And, the moisture absorbent Material, Silica gel, is inserted into aluminum bag.

(2) Storage:

Storage Conditions

Before opening the package:

The LEDs should be kept at 30°C or less than 90%RH or less. The LEDs should be used within a year. When storing the LEDs, moisture proof packaging with absorbent material is recommended.

After opening the package:

After open the package, the LED should be kept at 30°C, 60%RH or less. The LED should be soldered within 168 hours (7 days) after opening the package. If unused LEDs remain, it should be stored in moisture proof condition.

(3) Heat Generation

Thermal design of the end products is of paramount importance. The heat generation must be taken into design consideration when using the LED. The coefficient of the temperature increase per input electric power is affected by the thermal resistance of the circuit board and density of LED placement on the board, as well as other components.

(4) Static Electricity

Static electricity or surge voltage damages the LEDs. All equipment and machinery must be properly grounded. It is recommended to use a wristband or anti-electrostatic glove when handling the LEDs. When inspecting the final products in which LEDs were assembled, it is recommended to check whether the assembled LEDs are damaged by static electricity or not. It is easy to find static-damaged LEDs by a light-on test or a Vf test at a lower current. (Below 1mA is recommended).

Criteria: $V_f > 1.9V$ at $I_f = 1 \mu A$

(5) Cleaning

Use isopropyl alcohol as a solvent for cleaning the LEDs. The other solvent may dissolve the LEDs package and the epoxy.

Ultrasonic cleaning should not be done.

(6) Electrostatic Discharge (ESD)

The products are sensitive to static electricity or surge voltage, An ESD event may damage its die or reduce its reliability performance. When handling the products, measures against electro static discharge, including the followings, are strongly recommended.

Eliminating the charge;

Wrist strap, ESD footwear and garments, ESD floors



Solid-State Light. Done Right.

Grounding the equipment and tools at workstation

ESD table / shelf mat (conductive materials)

Proper grounding techniques are required for all devices, equipment and machinery used in the assembly of the products, Also note that surge protection should be considered in the design of customer products.

If tools or equipment contain insulating materials, such as glass or plastic, proper measures against electro static discharge, including the followings are strongly recommended.

Dissipating the charge with conductive materials

Preventing the charge generation with moisture

Neutralizing the charge with ionizer

(7) Others

When using the LEDs, it must care that the reverse voltage will not exceed the absolute maximum rating.

The LED light is enough to injure human eyes, so it should avoid looking at LED light directly.

NOTE.

All the information published is considered to be reliable. However, AOT does not assume any liability arising out of the application or use of any product described herein.

AOT reserves the right to make changes at any time without notice to any products in order to improve reliability, function or design.

AOT products are not authorized for use as critical components in life support devices or systems without the express written approval from the managing director of AOT.