

## APPROVAL SHEET

AOT MODEL NAME	3939
AOT PART NUMBER	3939UVB
CUSTOMER NAME	General Customer
DATE	2020 / NOV.
VERSION	01

MAKER			CUSTOMER			
Prepared	Checked	Approved				
TENTATIVE						

**AOT Headquarters**  
No. 13, Gongye 5th. Road, Hsinchu Industrial Park, Hukou Shiang,  
Hsinchu Hsien 303, Taiwan, R.O.C.  
TEL: +886-3-597-6988 / FAX: +886-3-598-7392



## Package Outline

Model name: **3939UVB**

Unit: mm, Tolerance:  $\pm 0.2$  mm

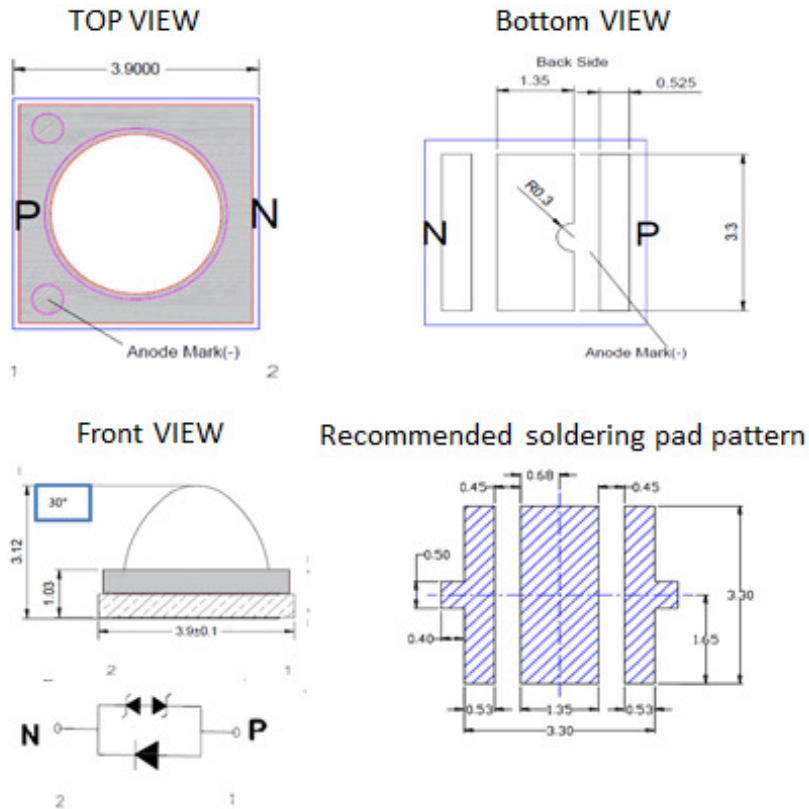

Item	Materials
Package	Ceramic
Encapsulating Material	Quartz Glass

- Single UVB chip.
- Compact package outline (LxWxH) of 3.9 mm x 3.9 mm x 3.12 mm.
- Compatible with reflow soldering.
- Complies with RoHS Directive.

## Optical/Electronic Characteristics (T<sub>s</sub>=25°C)

AOT Reading Standards(T <sub>s</sub> =25°C)						
Item	Symbol	Condition	Min	Typ.	Max	Unit
Forward Voltage	V <sub>F</sub>	I <sub>F</sub> = 350mA	5.0	-	9.0	V
Radiant Flux	θ <sub>e</sub>	I <sub>F</sub> = 350mA	30	-	50	mW
Thermal Resistance	R <sub>thj-s</sub>	I <sub>F</sub> = 350mA	-	12.5		°C/W

\* Tolerance of measurements of the Forward Voltage is ± 0.5 V.

\* Tolerance of measurements of the Luminous Flux is ± 10%.

## Absolute Maximum Ratings (T<sub>s</sub>=25°C)

Item	Symbol	Absolute Maximum Rating	Unit
Forward Current	I <sub>F</sub>	350	mA
Operating Temperature	T <sub>opr</sub>	-30~+60 (I <sub>F</sub> =350mA)	°C
Storage Temperature	T <sub>stg</sub>	-40~+80	°C
Soldering Temperature	T <sub>sld</sub>	Reflow Soldering : 260°C for 10sec	
Junction Temperature	T <sub>j</sub>	85	°C
Viewing Angle	2θ <sub>½</sub>	30	Deg

\* Max Condition is not guarantee for Life time

Notes:

- (1) For other ambient, limited setting of current will depend on de-rating curves. .
- (2) When drive on maximum current, T<sub>j</sub> must be kept below 85°C.
- (3) Viewing angle(2θ<sub>½</sub>)±10°
- (4) D=0.01s duty 1/10

## Group Definition of Forward Voltage

Rank	Condition	V <sub>F</sub> (V)
V1	T <sub>s</sub> =25°C	5.0 ~ 7.0
V2	I <sub>F</sub> =350mA	7.0 ~ 9.0

## Group Definition of Brightness

Rank	Condition	AOT Radiant Flux(mW)
A1	T <sub>s</sub> =25°C I <sub>F</sub> =350mA	30 ~ 50

\*A shipment shall consist of LEDs in a combination of above ranks.

\*The percentage of each rank in the shipment shall be determined by AOT.

\*The ranking information of LEDs can be found on the reel label.

## Group Definition of Peak-Wavelength

Rank	Condition	AOT Peak Wavelength(nm)
UVB	T <sub>s</sub> =25°C I <sub>F</sub> =350mA	300 ~ 315

\*Wavelength tolerance±2nm.

Radiation Pattern( $T_A=25^\circ\text{C}$ ,  $I_{FP}=350\text{mA}$ )

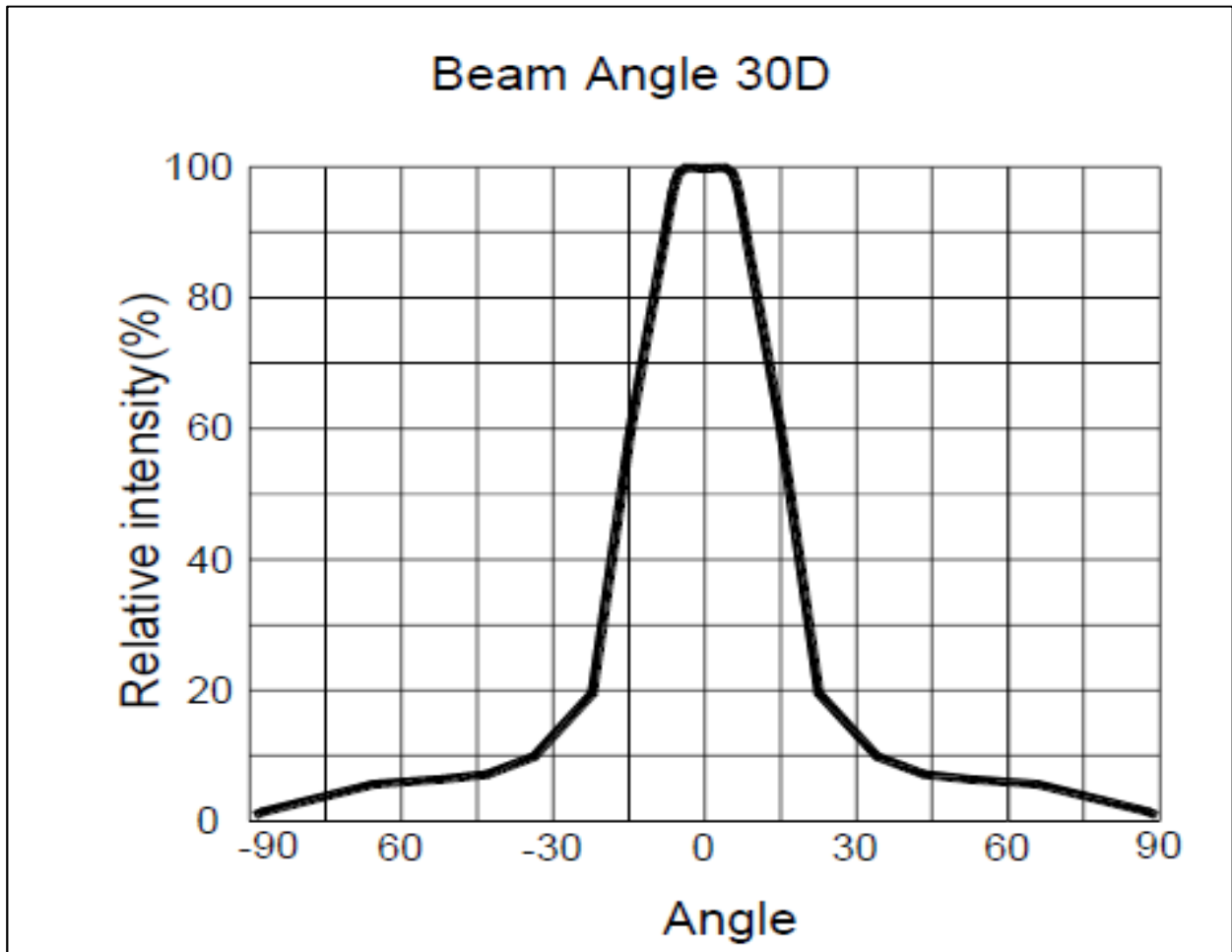

## Recommended Reflow Soldering Conditions

### Surface Mounting Condition

In automatic mounting of the SMD LEDs on printed circuit boards, any bending, expanding and pulling forces or shock against the SMD LEDs should be kept min. to prevent them from electrical failures and mechanical damages of the devices.

### Soldering Reflow

- Soldering of the SMD LEDs should conform to the soldering condition in the individual specifications.
- SMD LEDs are designed for Reflow Soldering.
- In the reflow soldering, too high temperature and too large temperature gradient such as rapid heating/cooling may cause electrical & optical failures and damages of the devices.
- AOT cannot guarantee the LEDs after they have been assembled using the solder dipping method.

#### 1) Lead Solder

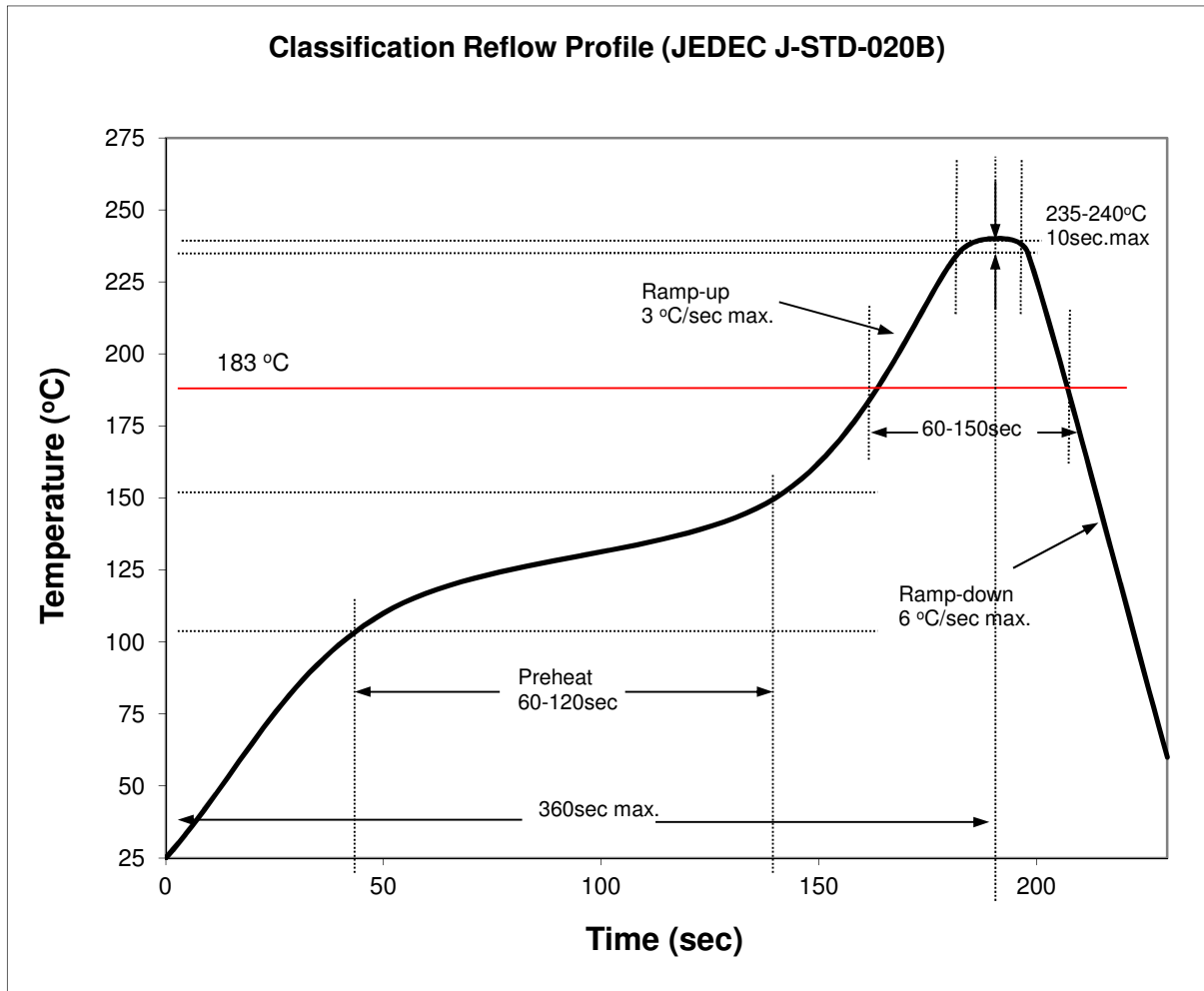

## 2) Lead-Free Solder

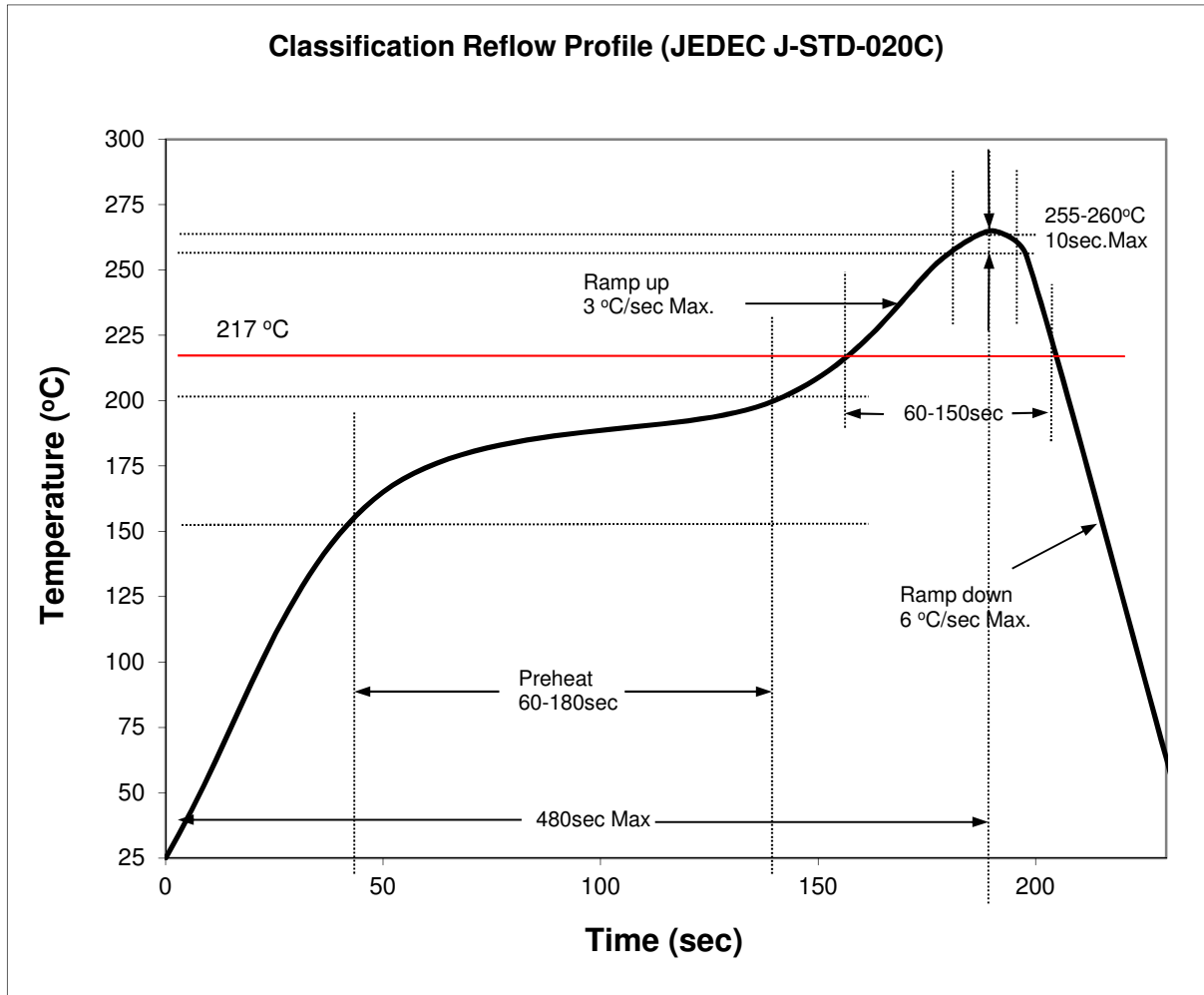

## 3) Manual Soldering Conditions

- Lead Solder

Max. 300 °C for Max. 3sec, and only one time.

- Lead-free Solder

Max. 350 °C for Max. 3sec, and only one time.

- There is possibility that the brightness of LEDs is decreased, which is influenced by heat or ambient atmosphere during reflow. It is recommended to use the nitrogen reflow method.

- After LEDs have been soldered, repair should not be done. As repair is unavoidable, a double-head soldering iron should be used. It should be confirmed beforehand whether the characteristics of the LEDs will be damaged by repairing or not.

- Reflow soldering should not be done more than two times.



## Dimensions (Unit :mm)

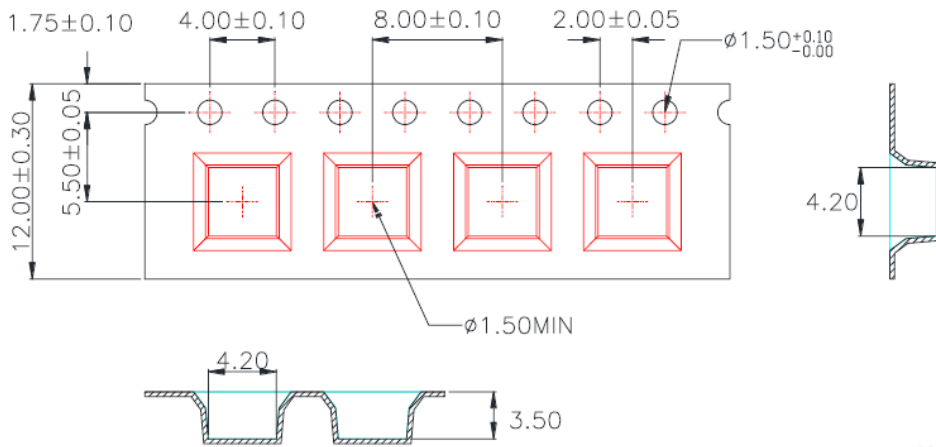

1. 10 sprocket hole pitch cumulative tolerance  $\pm 0.20$ .
2. Carrier camber is within 1 mm in 250 mm.
3. Material : Black Conductive Polystyrene Alloy.
4. All dimensions meet EIA-481-D requirements.
5. Thickness :  $0.30 \pm 0.05$ mm.
6. Packing length per 22" reel : 62.5 Meters(1:3).
7. Component load per 13" reel : 2500 pcs.



Taiwan Patent No : 157713  
China Patent No : 01224591.7

W	12.00±0.30
A0	4.20±0.10
B0	4.20±0.10
K0	3.50±0.10

## Packing Formation

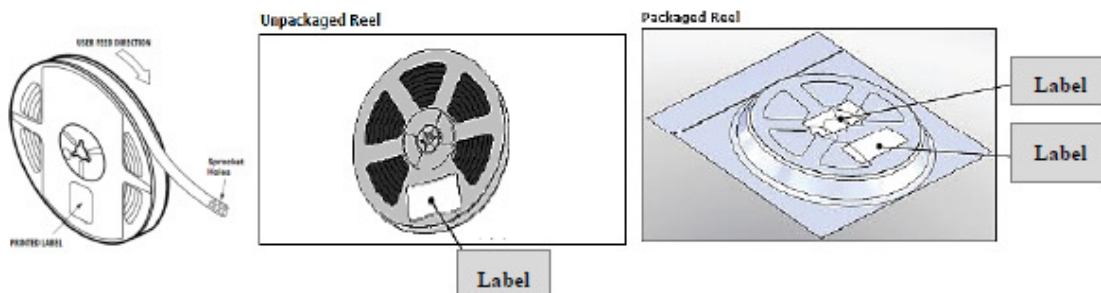
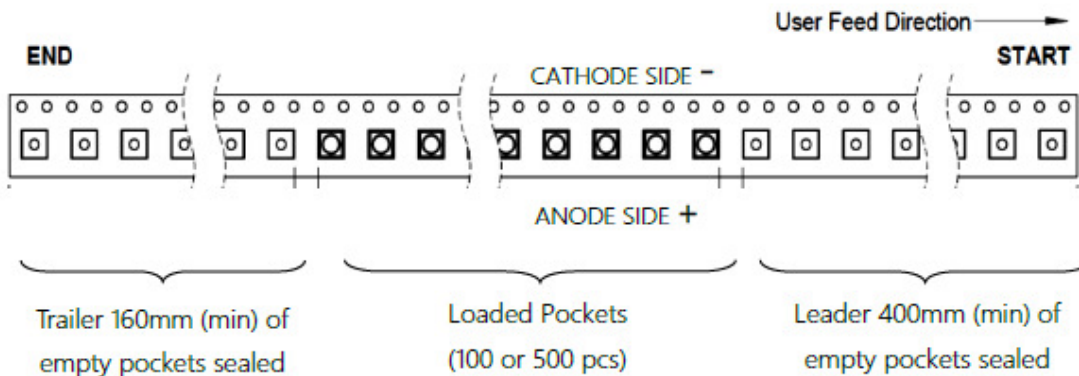

## **Cautions**

### (1) Moisture Proof Package

The moisture proof package should be used to prevent moisture in the package as the moisture may Cause damage to optical characteristics of the LEDs.

The aluminum bag with zipper is used for moisture proof package. And, the moisture absorbent Material, Silica gel, is inserted into aluminum bag.

### (2) Storage:

Storage Conditions

Before opening the package:

The LEDs should be kept at 30°C or less than 90%RH or less. The LEDs should be used within a year. When storing the LEDs, moisture proof packaging with absorbent material is recommended.

After opening the package:

After open the package, the LED should be kept at 30°C, 60%RH or less. The LED should be soldered within 168 hours (7 days) after opening the package. If unused LEDs remain, it should be stored in moisture proof condition.

### (3) Heat Generation

Thermal design of the end products is of paramount importance. The heat generation must be taken into design consideration when using the LED. The coefficient of the temperature increase per input electric power is affected by the thermal resistance of the circuit board and density of LED placement on the board, as well as other components.

### (4) Static Electricity

Static electricity or surge voltage damages the LEDs. All equipment and machinery must be properly grounded. It is recommended to use a wristband or anti-electrostatic glove when handling the LEDs. When inspecting the final products in which LEDs were assembled, it is recommended to check whether the assembled LEDs are damaged by static electricity or not. It is easy to find static-damaged LEDs by a light-on test or a Vf test at a lower current. (Below 1mA is recommended).

Criteria:  $V_F > 1.9V$  at  $I_F = 1\mu A$

### (5) Cleaning

Use isopropyl alcohol as a solvent for cleaning the LEDs. The other solvent may dissolve the LEDs package and the epoxy.

Ultrasonic cleaning should not be done.

### (6) Electrostatic Discharge (ESD)

The products are sensitive to static electricity or surge voltage, An ESD event may damage its die or reduce its reliability performance. When handling the products, measures against electro static discharge, including the followings, are strongly recommended.

Eliminating the charge;

Wrist strap, ESD footwear and garments, ESD floors

Grounding the equipment and tools at workstation

ESD table / shelf mat (conductive materials)

Proper grounding techniques are required for all devices, equipment and machinery used in the assembly of the products, Also note that surge protection should be considered in the design of customer products.

If tools or equipment contain insulating materials, such as glass or plastic, proper measures against electro static discharge, including the followings are strongly recommended.

Dissipating the charge with conductive materials

Preventing the charge generation with moisture

Neutralizing the charge with ionizer

## (7) Recommendation for using LEDs

(7-1) The lens of LEDs should not be exposed to dust or debris. Excessive dust and debris may cause a drastic decrease in the luminosity.

(7-2) Avoid mechanical stress on LED lens.

(7-3) Do not touch the LED lens surface. It would affect the optical performance of the LED due to the LED lens' damage.

(7-4) Pick & place tools are recommended for the remove of LEDs from the factory tape & reel packaging.

(7-5) The pickup tool was recommended and shown as below.

(7-6) The Lens of LEDs should not be exposed to dust or debris. Excessive dust and debris may cause a drastic decrease in the luminosity.

(7-7) Avoid mechanical stress on LED lens.

(7-8) Do not touch the LED lens surface. It would affect the optical performance of the LED due to the LED lens damage.

(7-9) Pick & place tools are recommended for the remove of LEDs from the factory tape & reel packaging.

(7-10) Pick & place nozzle the pickup tools was recommended and shown as below.

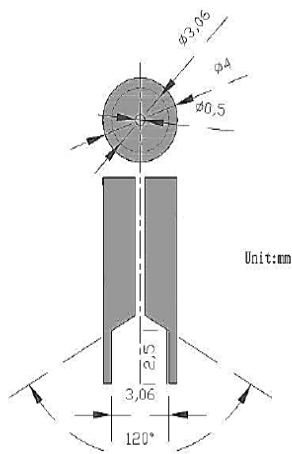

(8) Lens handling please follow the guideline to pick LEDs

(8-1) Use tweezers to pick LEDs

(8-2) Do not touch the lens by using tweezers.

(8-3) Do not touch lens with fingers.

(8-4) Do not apply more than 4N of lens (400g) directly onto the lens.

(9) Lens cleaning in the case which a small amount of dirt and dust particles remain on the lens surface, a suitable cleaning solution can be applied.

(9-1) Try a gently wiping with dust-free cloth.

(9-2) If needed, use dust-free cloth and isopropyl alcohol to gently clean the dirt from the lens surface.

(9-3) Do not use other solvents as they may directly react with the LED assembly.

(9-4) Do not use ultrasonic cleaning which will damage the LEDs.

(10) Others

When using the LEDs, it must care that the reverse voltage will not exceed the absolute maximum rating.

The LED light is enough to injure human eyes, so it should avoid looking at LED light directly.

---

## NOTE.

---

All the information published is considered to be reliable. However, AOT does not assume any liability arising out of the application or use of any product described herein.

AOT reserves the right to make changes at any time without notice to any products in order to improve reliability, function or design.

AOT products are not authorized for use as critical components in life support devices or systems without the express written approval from the managing director of AOT.